

Como tú, fuimos farmacéuticos antes que ortopedas.

Por ello, sabemos el reto que supone recomendar y dispensar artículos de esta gran familia y convertir tu farmacia en un referente de la ortopedia.

Una categoría con futuro y muchas oportunidades, no solo por el aumento del envejecimiento de la población, sino porque nos acompaña, trata y ayuda desde que nacemos hasta que nos hacemos mayores. Desde cojines para neonatos, órtesis para el cuidado de los pequeños traviesos, fajas de embarazo, productos para patologías muy comunes del día a día y, por supuesto, las ayudas técnicas para mantener la vitalidad de las personas mayores de forma segura o dar apoyo y soporte en los casos de convalecencia.

Con una estructura fácil e intuitiva, este catálogo pretende ser una guía para la atención farmacéutica ante consultas o prescripciones relacionadas con esta categoría.

Los artículos que aparecen han sido seleccionados meticulosamente.

Probando, comparando y valorando cada uno de ellos individualmente, entre más de 20 proveedores y 1.000 referencias. Pensando en hacer la mejor selección para cubrir cada patología, con las distintas necesidades de los pacientes y, a la vez, garantizarte la mayor rentabilidad y eficiencia de surtido.

Desde **fedefarma**, queremos darte el máximo apoyo en la gestión y recomendación de la ortopedia. Así que no dudes en contactarnos para resolver cualquier duda o hacernos una sugerencia: **[ortopedia@fedefarma.com](mailto:ortopedia@fedefarma.com)**

Esperamos que te guste y te resulte realmente útil.

**#ActivaLaOrtopedia**

## ICONOGRAFÍA

En este catálogo encontrarás una serie de iconos que te ayudarán a relacionar rápidamente los productos descritos, con sus características específicas.



### PAO BAS

Este icono lo encontrarás en los productos que entran en la S.S. considerados de adaptación básica. Todas las farmacias los pueden dispensar. **Tan solo deberás darte de alta en Sanidad.** ¿No sabes cómo? escribenos a [ortopedia@fedefarma.com](mailto:ortopedia@fedefarma.com).



### PAO ADAP

Este icono lo encontrarás en los productos que entran en la S.S. considerados como productos que requieren una mínima adaptación por parte del facultativo. Según el nivel de adaptación, se separan en ADAP1, ADAP2 y ADAP3 (en este catálogo encontrarás productos ADAP1 y algún ADAP2 habitual).

Las farmacias que pueden dispensar este tipo de productos por PAO son farmacias con unos requisitos de espacio y de formación mínimos obligatorios.



### STOCK

Este icono lo encontrarás en productos muy polivalentes que evitan tener distintos modelos para cada lado, tallas o accesorios. Por lo que, con su incorporación en el stock de la farmacia, resuelves varias consultas o patologías.



### DIAMANTE

El símbolo del diamante lo encontrarás en aquellos productos que tienen características, tejidos o beneficios especiales que hacen que los consideremos productos de alta calidad.



### TERCERA EDAD

Este icono lo encontrarás en los productos que, según nuestra experiencia en mostrador, son más agradecidos para gente con un perfil más senior. Por el tipo de tejido, facilidad de colocación, tipo de compresión o buena adaptabilidad, y sobre todo, el color.



### Oferta

Este icono lo encontrarás en aquellos productos con precio muy especial.

Dato relevante

### Dato relevante

Hemos optado por no poner datos muy técnicos y sí muy prácticos para la venta en mostrador. ¡Esperamos que te resulten útiles!



### E-mail

[ortopedia@fedefarma.com](mailto:ortopedia@fedefarma.com)  
Hay productos/servicios que por sus características deberás pedirlos vía e-mail.



### Información

Este símbolo lo encontrarás en las definiciones de patologías que creemos relevantes o, por el contrario, más desconocidas.



### Atención

Este símbolo marca comentarios que creemos pueden ser de utilidad en caso de no encontrar lo que buscas en estas páginas.



### Frio



### Calor



### Reposo



### Estiramientos

Es básico hacer estiramientos para conseguir una buena salud física o recuperación. Los estiramientos varían según el grupo muscular afectado.



### Esguince de tobillo

## ÍNDICE

- CABEZA Y CUELLO** .....P.7
- EXTREMIDAD SUPERIOR** .....P.13
- TRONCO** .....P.25
- EXTREMIDAD INFERIOR** ..... P.33
- PIE** ..... P.43
- ESPECIAL DEPORTE** .....P.57  
En esta sección encontrarás las patologías típicas del deporte y los productos relacionados. Cualquier órtesis de temas anteriores sería válida, pero los diseños y tejidos que te presentamos aquí, están pensados para tal fin.
- REHABILITACIÓN** ..... P.67  
Tan importante es tratar la dolencia como seguir las pautas para una buena recuperación. En este tema encontrarás nuestra propuesta para ello.
- PEDIATRÍA-INFANCIA** .....P.75  
Desde cojines, protectores deportivos y órtesis, hasta muletas y sillas.
- MUJER** ..... P.83  
En esta sección abordamos todo lo que una mujer puede necesitar en algún momento: embarazo, reductores, post operatorios y productos relacionados.
- VASCULAR** ..... P.89  
Medias y calcetines
- MOVILIDAD** ..... P.99  
Muletas, bastones, sillas, scooters y accesorios
- AYUDAS** ..... P.131
  - Baño ..... P.133
  - Incorporación/ movilización de pacientes .....P.137
  - Descanso .....P.140
  - Incontinencia..... P.143
  - Cotidianas/medicación ..... P.145
- ANTIESCARAS** ..... P.149  
Cojines, colchones, patucos
- PATOLOGÍA RESPIRATORIA/ PRODUCTOS VARIOS** ..... P.155
- PRODUCTOS DE ALQUILER Y SERVICIOS DE ATENCIÓN DOMICILIARIA**.....P.159
- PAOS** ..... P.163

# 1 CABEZA Y CUELLO

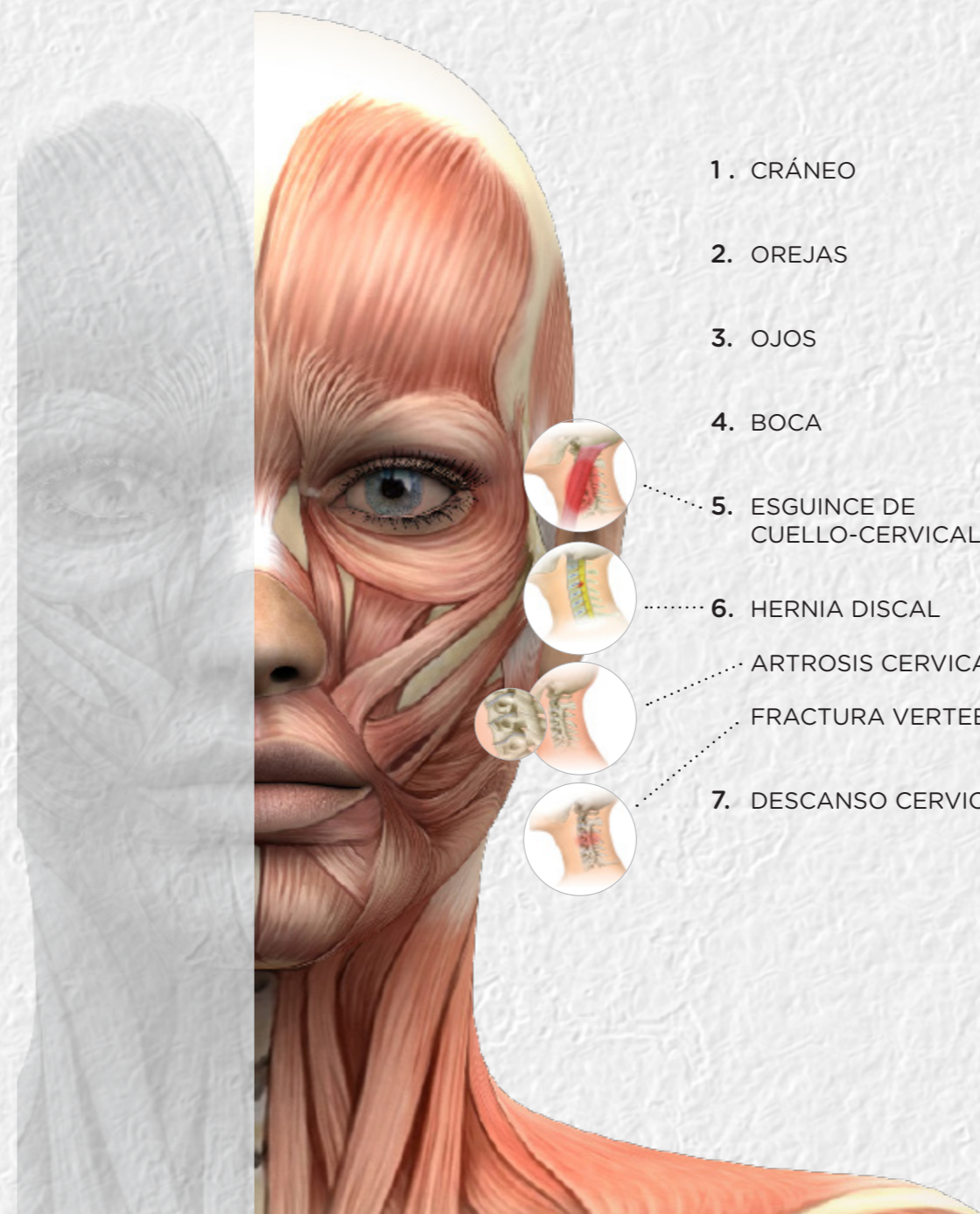

## Patologías

1. CRÁNEO
2. OREJAS
3. OJOS
4. BOCA
5. ESGUINCE DE CUELLO-CERVICALGIA
6. HERNIA DISCAL  
ARTROSIS CERVICAL  
FRACTURA VERTEBRAL
7. DESCANSO CERVICAL

## Productos relacionados con las patologías

1. CASCOS PROTECTORES .....P.9
2. ALMOHADAS Y TAPONES PARA OÍDOS..... P.9
3. ANTIFACES/ALMOHADAS OCULARES..... P.10
4. FÉRULAS BRUXISMO ..... P.10
5. COLLARINES BLANDOS.....P.11
6. COLLARINES RÍGIDOS, SEMIRRÍGIDOS Y GRADUABLES.....P.11
7. COLLARINES DE VIAJE .....P.11

1 CASCOS PROTECTORES



QBIO  
CASCO DE  
NEOPRENO  
Adultos

Evita  
fracturas  
craneales

TALLA	PERÍMETRO	CN
S	55-67 cm	098653

2 ALMOHADAS Y TAPONES PARA OÍDOS



PRIM  
TAPONES  
DE CERA

Especial  
ronquidos

ENVASE	CN
6uds	253427
12uds	161783



PRIM  
TAPONES  
DE  
SILICONA

Para  
moteros/  
técnicos  
de sonido

ENVASE	CN
6uds	328807



PRIM  
TAPONES  
DE  
ESPUMA  
PVC

Ideal  
entorno  
industrial/  
estudio

ENVASE	CN
PAR	254680



PRIM  
TAPONES  
DE RESINA  
SINTÉTICA

Baño y  
ducha

ENVASE	CN
6uds	170340



PRIM  
TAPONES  
DE LÁTEX

Especial  
otitis

ENVASE	CN
PAR	331629



PRIM  
DE ESPUMA DE  
POLIURETANO

Conciertos/  
Viajes

ENVASE	CN
10uds	150390



PRIM  
TAPONES  
PRESSURE

Ideal  
aviones

ENVASE	CN
PAR	194190

 Patología



**CONDRODERMATITIS:**  
Formación de un  
nódulo doloroso en el  
pabellón auricular.

Puede originarse por una disminución de flujo sanguíneo debido a períodos prolongados de presión sobre el cartilago auricular.

**RECOMENDACIONES:**  
Acudir al dermatólogo e iniciar tratamiento tópico con corticoides, nitroglicerina y en casos extremos, cirugía.

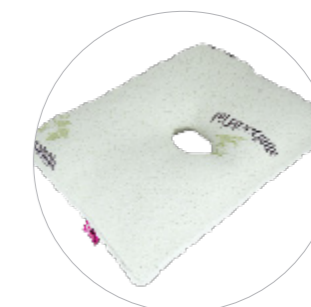

QBIO  
116100  
ALMOHADA  
CONDRODERMATITIS

MEDIDAS	CN
50X11X42 cm	189359

### 3 ANTIFACES/ALMOHADAS OCULARES



**PRIM**  
Antifaz de terciopelo para descanso

ENVASE CN  
UNIDAD 073466

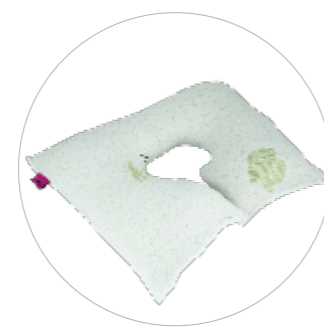

**QBIO**  
Almohada ocular  
Ideal para dormir boca abajo

ENVASE CN  
UNIDAD 189361

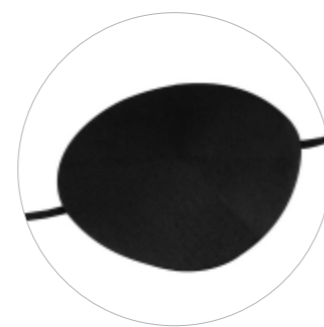

**PRIM**  
Protector ocular

ENVASE CN  
UNIDAD 043169



**GARCÍA 2909**  
Máscara de frío/calor

ENVASE CN  
UNIDAD 097941

Apto para microondas y congelador



**GARCÍA 2908**  
Antifaz frío/calor con perlas de gel  
Se adaptan mejor a la anatomía del rostro

ENVASE CN  
UNIDAD 097942

### 4 FÉRULAS BRUXISMO



**MC DAVID EZGARD WHITE ADULT**  
Protector bucal

ENVASE CN  
UNIDAD 053017



**PRIM**  
Estuche de prótesis dental

ENVASE CN  
PAR 065679



**GARCÍA 2380**  
Contenedor de prótesis dentales

CN  
098165

### 5 COLLARINES BLANDOS

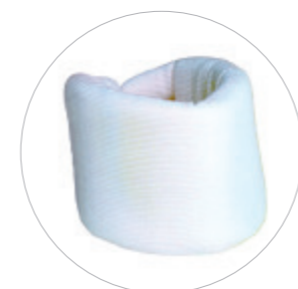

**PRIM CC20**  
Diseño anatómico  
Funda de algodón

TALLA	ALTURA	PERÍMETRO	CN
BAJO	8		098267
MEDIO	9	(S) 42-58 cm	098268
ALTO	10		098270
ALTO	8		098271
MEDIO	9	(L) 47-63 cm	098272
BAJO	10		098273



**ORLIMAN ACV202**  
Diseño anatómico  
Funda extraíble y lavable

TALLA	PERÍMETRO	CN
1	30-34 cm	191707
2	35-39 cm	191708
3	40-44 cm	191709



**FARMALASTIC INNOVA**  
Diseño anatómico

TALLA	CN
U	156171



### 6 COLLARINES RÍGIDOS

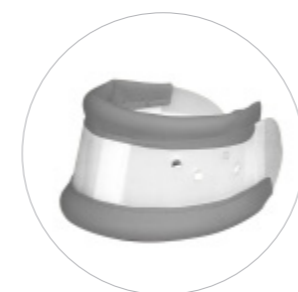

**PRIM E41**  
Polietileno y polipiel  
Regulable en altura

TALLA	PERÍMETRO/ALTURA	CN
XS	32-37 cm / 7,5-9 cm	098276
S	36-41 cm / 8-9,5 cm	069751
M	40-45 cm / 8,5-10 cm	069408
L	44-49 cm / 9-10,5 cm	098278
XL	48-53 cm / 9-10,5 cm	098279



Circunferencia y altura cuello



**PRIM E120**  
Polietileno y polipiel  
Regulable en altura y apoyo mentón

TALLA	PERÍMETRO/ALTURA	CN
XS	32-37 cm / 7,5-9 cm	098274
S	36-41 cm / 8-9,5 cm	076608
M	40-45 cm / 8,5-10 cm	076607
L	44-49 cm / 9-10,5 cm	076606
XL	48-53 cm / 9-10,5 cm	098275



**DJO Collarín california**  
Con agujero para traqueotomías

TALLA	PERÍMETRO CUELLO	CN
T/PED	17,5-25,5 cm	098917
T/S	26-33 cm	098918
T/M	33,5-40,5 cm	098919
T/L	41-48 cm	098920



**THUASNE ORTEL C4 VARIO**  
Ofrece 4 puntos de apoyo regulables en altura

TALLA	PERÍMETRO	ALTURA	CN
U	31-48 cm	9-16 cm	099262



### 7 COLLARINES CERVICALES



**QBIO Anatómico Marino**  
Inflable

ENVASE CN  
UNIDAD 189363

Especial viaje



**QBIO Anatómico.**  
Con funda de bambú transpirable y lavable  
Viscoelástico

ENVASE CN  
UNIDAD 099095



**VETTEL**  
¡Elige entre 3 materiales distintos!

TALLA	REFERENCIA	CN
ALGODÓN	AD490	098355
POLIURETANO	AD492	098357
SUAPEL	AD491	098356

## 2 EXTREMIDAD SUPERIOR

### Patologías



### Productos relacionados con las patologías

1. INMOVILIZADORES CLAVICULARES ..... P.15
2. CABESTRILLOS ..... P.15
3. POST-OPERATORIO CODO..... P.16
4. FÉRULAS BRAQUIALES ..... P.16
5. CODERAS Y CINCHAS ..... P.17
6. MUÑEQUERAS ELÁSTICAS ..... P.18
7. MUÑEQUERAS CON FÉRULA PALMAR ..... P.19
8. MUÑEQUERAS LARGAS E INMOVILIZADORAS DE PULGAR ..... P.20
9. MUÑEQUERAS CON SOPORTE DE PULGAR .... P.21
10. FÉRULAS EXTENSORAS E INMOVILIZADORES DE DEDOS ..... P.22
11. ÓRTESIS PALMARES DE POSICIÓN..... P.23



# 1 INMOVILIZADORES CLAVICULARES



PRIM  
CLAVI+

Discreta

TALLA	PERÍMETRO	CN
S	65-80 cm	099608
L	>80 cm	099607



Contorno



TEYDER  
420CH

Un básico

TALLA	PERÍMETRO	CN
S	<70 cm	098371
M	71-80 cm	098370
L	81-90 cm	098369
XL	91-100 cm	098372



Contorno



TEYDER  
421CH

Con panel posterior

TALLA	PERÍMETRO	CN
S	70-80 cm	098375
M	80-90 cm	098374
L	90-100 cm	098373



Contorno

# 2 CABESTRILLOS

## 2.1 SIMPLES



GARCÍA  
2566

Solo una tira

TALLA	CN
T/U	097944



ORLIMAN  
ACV307

Transpirable  
Con apoyo en dedo pulgar

TALLA	CN
T/U	198173



PRIM  
909

Acolchado

TALLA	LONGITUD	CN
S	<30 cm	199327
M	30-42 cm	199328
L	>42 cm	199329



Largo



CINFA  
FARMALASTIC  
INNOVA

TALLA	CN
U	155533

## 2.2 INMOVILIZADORES



PRIM  
903

Cinta extraíble

TALLA	LONGITUD	CN
S	28-36 cm	087880
M	35-42 cm	046540
L	41-49 cm	046763
XL	48-56 cm	098280



Largo



TEYDER  
430CH

Acolchado

Cinta extraíble

TALLA	CN
T/U	098380



STOCK



DJO  
IMMOSCAP

Transpirable  
Bilateral

Evita sobrecargas.  
Uso prolongado

TALLA	PERÍMETRO	CN
XS	<90 cm	098902
S	91-100 cm	098903
M	101-110 cm	098904
L	111-120 cm	098914
XL	121-130 cm	098915
XXL	>130 cm	098916



Contorno



2.3 CON ABDUCCIÓN DE HOMBRO



TEYDER  
437CH

30°  
Abducción  
de hombro



TALLA	LONGITUD	CN
S	30-35 cm	098379
M	35-40 cm	098378
L	40-45 cm	098377



¿Necesitas otros  
grados de abducción?  
¡ESCRÍBENOS!

[ortopedia@fedefarma.com](mailto:ortopedia@fedefarma.com)

3 POST-OPERATORIO CODO

3.1 ÓRTESIS ARTICULADA



PRIM  
C202

- Control de 0 a 90° de la extensión
- Control de 0° a 120° de la flexión
- Barra lateral extensible de 36 a 45cm



TALLA	IZQ	DCHA
U	098281	098282

3.2 ÓRTESIS FIJA



TEYDER  
432CD

Inmovilizador  
de codo  
sin flexión



TALLA	LONGITUD	CN
S	34 cm	098381
M	35 cm	098383
L	36 cm	098382

4 FÉRULAS BRAQUIALES



EMO  
FAB20

Con forro interno.  
Permite la movilidad  
de codo y muñeca



TALLA	PERÍMETRO	DCHA	IZQ
S	22 cm	098532	098536
M	25 cm	098534	098538
L	28 cm	098535	098539

5 CODERAS Y CINCHAS



Patología



**EPICONDILITIS:**  
Inflamación de los músculos  
y tendones que se insertan en  
el epicóndilo lateral del húmero  
(la protuberancia externa  
del codo) producida por los  
**movimientos repetitivos de  
extensión** de la muñeca  
y brazo.

RECOMENDACIONES:

Órtesis para  
descargar la  
zona dolorida



Estiramientos  
de la musculatura  
extensora

Frío: cuantas más  
veces, ¡MEJOR!



ACTIMOVE

Con  
almohadilla  
y banda



TALLA	PERÍMETRO	CN
S	20-23 cm	199144
M	23-26 cm	199145
L	26-29 cm	199146
XL	29-32 cm	199147



MC DAVID  
489

Con  
almohadillas  
de silicona

TALLA	PERÍMETRO	CN
S	20-24 cm	036151
M	24-28 cm	036153
L	28-30 cm	036154



3M  
FUTURO  
COMFORT  
47861

Con  
almohadilla  
y banda

TALLA	PERÍMETRO	CN
S	22,9-25,4 cm	210577
M	25,4-27,9 cm	210576
L	27,9-30,5 cm	210574



CINFA  
FARMALASTIC  
INNOVA

Con banda  
removible



TALLA	PERÍMETRO	CN
P	22-25 cm	316753
M	25-27 cm	316751
G	27-30 cm	316750



PRIM  
AQTIVO SKIN  
707BG

Elástica  
Con almohadilla  
y banda

TALLA	PERÍMETRO	CN
S	23-27 cm	188398
M	27-31 cm	188399
L	31-35 cm	188400



CINFA  
FARMALASTIC  
ADVANCE

Sistema Fix  
para que no  
se mueva



TALLA	CONTORNO	CN
U	16-32 cm	190952

! Encontrarás más modelos en la sección de deporte.

## 6 MUÑEQUERAS ELÁSTICAS

### Patología



**ESGUINCE:**  
Distensión leve de las fibras musculares del carpo/muñeca.

#### RECOMENDACIONES:

Compresión



Frío: cuantas más veces, ¡MEJOR!



**CINFA FARMALASTIC FINANCIADA**

Tubular básica



TALLA PERÍMETRO CN

P	14-17 cm	441444
M	17-20 cm	441451
G	20-23 cm	441469



**PRIM AQTIVO SKIN P703BG**

Tubular con cinta de ajuste



TALLA CN

U	188373
---	--------



**EMO STP035**

Strapín de muñeca

Cinta elástica. Muy versátil

TALLA CN

U	098540
---	--------



**CINFA FARMALASTIC INNOVA**

Con velcro

TALLA COLORES CN

P/M	BLANCO	158665
G/EG		158666
P/M	BEIGE	200710
G/EG		200711



**ORLIMAN ACE 501**

Abierta con cinta de ajuste

TALLA CN

U	198156
---	--------



**PRIM AQTIVO SKIN P704BG**

Metacarpiana



TALLA PERÍMETRO CN

1	15-18 cm	188378
2	18-21 cm	188379
3	21-24 cm	188380



**ORLIMAN ACE 502**

Metacarpiana. Se ensucia menos

TALLA PERÍMETRO CN

1	15-18 cm	198157
2	18-21 cm	198158
3	21-24 cm	198159



**CINFA FARMALASTIC ADVANCE**

Estabilizadora. Universal



TALLA PERÍMETRO CN

1	14-23 cm	190958
---	----------	--------

## 7 MUÑEQUERAS CON FÉRULA PALMAR

Extremidad superior

### Patología



**SÍNDROME DEL TÚNEL CARPIANO:**  
Engrosamiento del ligamento del carpo, comprimiendo el nervio medial que irriga los 3 primeros dedos de la mano. El paciente sentirá entumecimiento, calambres y pérdida de fuerza.

#### RECOMENDACIONES:

FASE AGUDA:



+ FÉRULA DÍA Y NOCHE

FASE PREVENTIVA:

FÉRULA POR LA NOCHE



mala postura



buena postura

Este modelo de prim es el corto. La referencia del largo es la C600.



**ACTIMOVE MANUMOTION**  
Más cómoda para trabajar. Permite cierto movimiento



TALLA PERÍMETRO DCHA IZQ

XS	14-15 cm	098216	098222
S	15-16 cm	098217	098223
M	16-17 cm	098218	098224
L	17-18 cm	098219	098225
XL	18-19 cm	098220	098226
XXL	19-20 cm	098221	098227



**PRIM ESSENCIAL C500**



TALLA PERÍMETRO DCHA IZQ

S	12-15 cm	078632	078631
M	15-17 cm	078630	078628
L	17-19 cm	078627	078640
XL	19-21 cm	078635	078633



**ACTIMOVE MANUS FORTE**



TALLA PERÍMETRO DCHA IZQ

XS	10-14 cm	097890	098215
S-M	14-19 cm	097446	097447
L-XL	19-23 cm	097891	097892



**CINFA FARMALASTIC ADVANCE**

Diseño atractivo



TALLA PERÍMETRO CN

1	14-18 cm	190954
2	18-23 cm	190955



TALLA CN

U	198156
---	--------

TALLA PERÍMETRO CN

1	15-18 cm	188378
2	18-21 cm	188379
3	21-24 cm	188380



TALLA PERÍMETRO CN

1	15-18 cm	198157
2	18-21 cm	198158
3	21-24 cm	198159



TALLA PERÍMETRO CN

1	14-23 cm	190958
---	----------	--------



**ORLIMAN IMMOTEC**

Con accesorio para inmovilizar el pulgar



TALLA PERÍMETRO CN

S	14-18 cm	191587
L	18-22 cm	191588



**PRIM AIRMED AM205G**



TALLA PERÍMETRO CN

1	14-18 cm	199319
2	12-22 cm	199320



**3M FUTURO 10770**



TALLA PERÍMETRO CN

U	14-21.5 cm	208540
---	------------	--------



**3M FUTURO 48462**

Soporte nocturno

Tiene un "cojín" en la mano súper cómodo



TALLA PERÍMETRO CN

U	13,3-22,9 cm	162422
---	--------------	--------

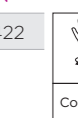

Aunque las muñequeras ambidiestras están muy conseguidas, los productos con tallas y lados se adaptan mejor.

! Encontrarás más modelos en la sección de deporte.

## 8 MUÑEQUERAS LARGAS E INMOVILIZADORAS DE PULGAR



### Patología



#### TENDINITIS DE QUERVAIN

Inflamación de los tendones extensores (o la vaina) del pulgar. El paciente sentirá dolor al mover el pulgar y aguantar peso.

#### RECOMENDACIONES:

Férula durante el día



Estiramientos de los tendones extensores del pulgar

Frío: cuantas más veces, ¡MEJOR!

Este modelo de prim es el largo. La referencia del corto es el C700.



#### ACTIMOVE MANUS FORTE PLUS



TALLA	PERÍMETRO	DCHA	IZQ
XS	10-14 cm	097893	097897
S-M	14-19 cm	097894	097448
L-XL	19-23 cm	097985	097900



#### PRIM ESSENCIAL C800



TALLA	PERÍMETRO	DCHA	IZQ
S	12-15 cm	078652	078653
M	15-17 cm	078599	078617
L	17-29 cm	078280	078616
XL	19-21 cm	099087	078651



#### ORLIMAN ACE513 MANU EASY

Larga

¡Fácil colocación!  
¡Se puede mojar!



TALLA	PERÍMETRO	DCHA	IZQ
1	14-16 cm	196229	196232
2	16-18 cm	196230	196233
3	18-20 cm	196231	196234



#### ORLIMAN ACE506 MANU EASY

Corta

¡Fácil colocación!  
¡Se puede mojar!



TALLA	PERÍMETRO	DCHA	IZQ
1	12-16 cm	191573	191576
2	16-18 cm	191574	191578
3	18-20 cm	191575	191579



#### ORLIMAN ACE512P

Accesorio Inmotec



Estos accesorios entran por PAO junto con las muñequeras del apartado anterior

TALLA	CN
1	194698
2	194699



#### PRIM AIRMED AM201G

Accesorio AM205G



TALLA	CN
U	199321

## 9 MUÑEQUERAS CON SOPORTE PULGAR

Extremidad superior



### Patología



#### RIZOARTROSIS DE PULGAR:

Desgaste de la articulación trapecio-metacarpiana  
Dolor al presionar o mover.

#### RECOMENDACIONES:

Férula inmovilizadora de pulgar



Complementos con colágeno y antiinflamatorios

### TIPO 1: NO INMOVILIZAN LA ARTICULACIÓN. DAN SOPORTE Y/O CALOR



#### PRIM CMC DE PUSH 3101

Posiciona el dedo. El cliente suele venir con receta



TALLA	PERÍMETRO	DCHA	IZQ
1	16-19,5 cm	086799	085494
2	19,5-22,5 cm	085384	036264
3	22,5-26 cm	085525	035764

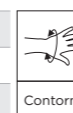

#### ORLIMAN RHIZO MP ACE510

Tejido muy ligero. Muy cómoda

TALLA	PERÍMETRO	DCHA	IZQ
1	<15 cm	191582	191584
2	>15 cm	191583	191586

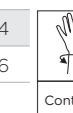

### TIPO 2: INMOVILIZAN LA ARTICULACIÓN AFECTADA



#### PRIM ESSENCIAL C400

Tejido elástico transpirable



TALLA	PERÍMETRO	CN
S	12-15 cm	078638
M	15-17 cm	078637
L	17-19 cm	078636
XL	19-21 cm	078639



#### ORLIMAN FP-174

Termoplástico



TALLA	PERÍMETRO/LARGO	DCHA	IZQ
1	<17/11 cm	077976	085090
2	17-19/12 cm	077977	085091
3	>19/13 cm	083656	085093



#### ACTIMOVE RHIZO FORTE

Se puede mojar  
¡Ideal para trabajar!



TALLA	LONGITUD	DCHA	IZQ
S	4,5-5,4 cm	179573	179576
M	5,5-6,3 cm	179574	179577



#### EMO MQ505

Termotejido transpirable



TALLA	PERÍMETRO	DCHA	IZQ
S	13-15 cm	098545	098548
M	15-18 cm	098546	098549
L	18-21 cm	098547	098550



#### CINFA FARMALASTIC ADVANCE

Gris/Marsala  
Diseño atractivo

TALLA	PERÍMETRO	CN
1	14-18 cm	190956
2	18-23 cm	190957



#### ORLIMAN ACE515 MANU EASY

¡De fácil colocación!  
¡Se puede mojar!



ENVASE	PERÍMETRO	CN
1	14-17 cm	196242
2	17-20 cm	196243



**TIPO 3: INMOVILIZA HASTA LA FALANGE DISTAL**



**PRIM 112900**

Termoplástico moldeable. Forrada en el interior



Esto es, que inmoviliza hasta la articulación más lejana del dedo pulgar. No permite "hacer la pinza".

TALLA PERÍMETRO IZQ DCHA

S	15-17 cm	076721	076719
M	17-19 cm	076716	076718
L	19-21 cm	076720	076717



Contorno

**10 FÉRULAS EXTENSORAS, FLEXORAS E INMOVILIZADORAS DE DEDOS**



**PRIM STACK 948**

Férula proximal



TALLA PERÍMETRO CN

1	5 cm	086060
2	5,5 cm	085301
3	5,8 cm	085309
4	6,1 cm	089031
5	6,3 cm	085190
6	7,3 cm	077757

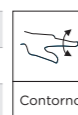

Contorno



**PRIM STACK 947**

Férula distal



TALLA PERÍMETRO CN

1	5 cm	076700
2	5,5 cm	076701
3	5,8 cm	076702
4	6,1 cm	076703
5	6,3 cm	076704
6	7,3 cm	076705

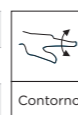

Contorno



**PRIM 940**

Inmovilizador digital

¡Protege la punta de golpes!



TALLA PERÍMETRO CN

S	5,5 cm	036099
M	7 cm	036100
L	8 cm	036101
XL	9,5 cm	036102



Contorno



**ORLIMAN ACV504**



TALLA LONGITUD CN

1	6,4 cm	191725
2	7 cm	191727
3	8,9 cm	191728

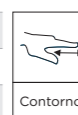

Contorno



**ORLIMAN ACV502**



TALLA LONGITUD CN

1	5,4 cm	191719
2	7 cm	191720
3	9,5 cm	191721



Contorno



**TEYDER 733MN**

¡Disponible en dos colores!



TALLA LONGITUD AZUL GRIS

S	5 cm	098389	098385
M	6 cm	098388	098384
L	6,5 cm	098387	099434
XL	8 cm	098390	098386



Perímetro dedo



**EMO INTERGRIP IF702**

Férula proximal

Inmoviliza la articulación interfalángica (IF) y metacarpofalángicas (MCF)

TALLA LONGITUD CN

S	13-16 cm	098551
M	16-19 cm	098552
L	19-22 cm	098553

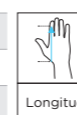

Longitud

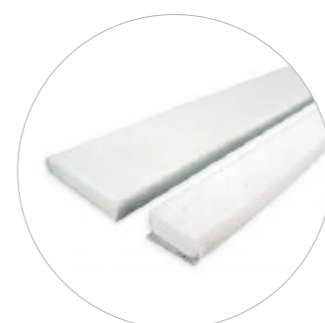

**CALVO IZQUIERDO**

Férula de aluminio

En bolsas de 10

MEDIDAS CN

2x50 cm	098323
---------	--------



**JOY PROTECT**

Espardapero cubre dedos autoadhesivo

¡2 en 1! Protege heridas y estabiliza articulaciones

COLORES MEDIDAS CN

AZUL	2X4,5 m	086055
BEIGE		086054
LILA		086052
VERDE		086053



**PRIM BUDDY LOOPS**

Banda inmovilizadora

MEDIDAS CN

1,5 cm	036096
1,8 cm	036097
2,5 cm	036098



Longitud

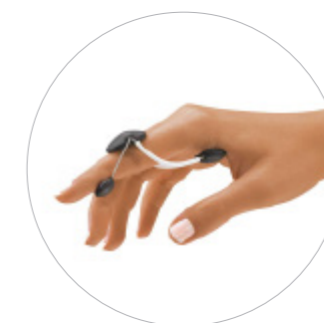

**PRIM 112510**

Férula extensora

Al doblar con cuidado el resorte, se puede aumentar o reducir la tensión



TALLA LONGITUD ANCHO CN

XS	5-6,3	1,3-1,5	046116
S	6,3-7,6	1,5-1,7	046395
S+	6,3-7,6	1,7-1,9	077505
M	7,6-8,9	1,7-1,9	046419
L	8,9-10,2	1,9-2,1	044514
L+	8,9-10,2	2,1-2,3	077671



Longitud



**THUASNE 601**

Férula flexora



TALLA LONGITUD CN

AA	32 mm	099160
A	38 mm	099161
B	44 mm	099162
C	57 mm	099163



Longitud

**11 ÓRTESIS PALMARES DE POSICIÓN**



**THUASNE AIR-SOFT STABLE 326**

Férula extensora

Acolchada. Se adapta muy bien



TALLA ANCHURA DCHA IZQ

S	57-70 mm	099142	099138
M	70-85 mm	099144	099139
L	85-95 mm	099145	099140
XL	95-105 mm	099146	099141



Contorno

Para pacientes con espasticidad y rigidez muscular.



**THUASNE PUCCI AIR ROLL 413**

Muy útil para abrir la mano



TALLA ANCHURA DCHA IZQ

M	80-110 mm	099149	099151
L	110-130 mm	099147	099148



Contorno

# 3 TRONCO



- 2. LESIONES COSTALES/TORÁCICAS
- 4. CIRUGÍA/CONTENCIÓN ABDOMINAL
- 5. OSTOMÍAS

## 6. HERNIA DISCAL



- PROTUSIÓN DISCAL



- PROLAPSO



- EXTRUSIÓN



- SECUESTRO

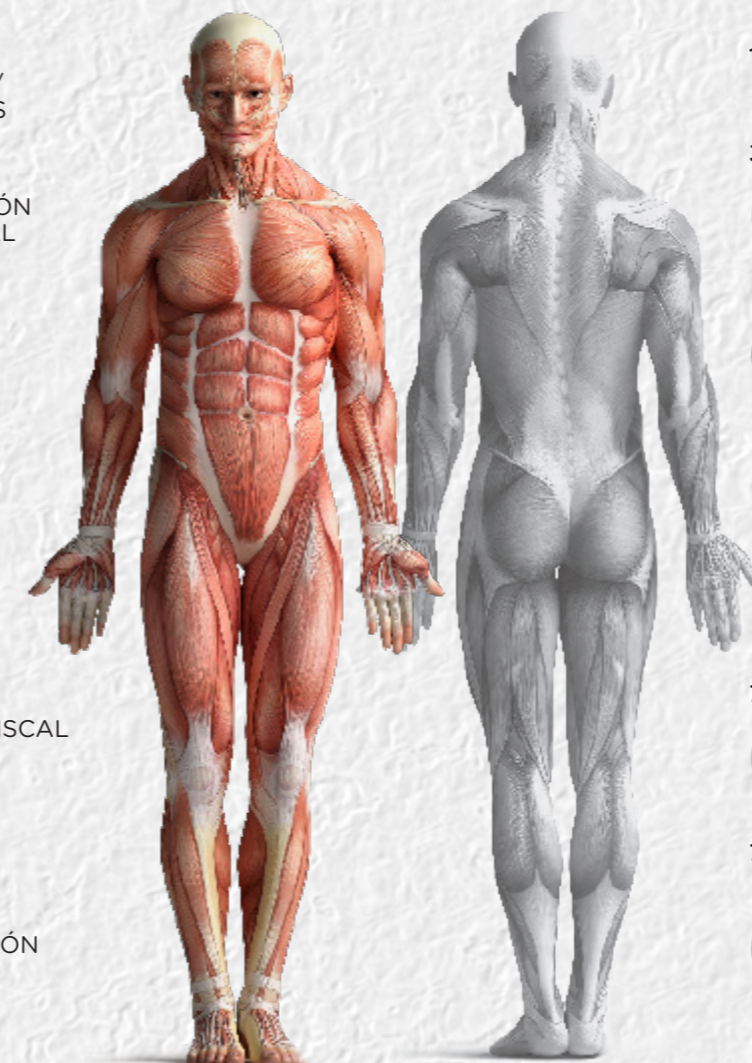

## Patologías

- 1. MALAS POSTURAS

- 3. DORSALGIA



- 6. LUMBALGIA



- 7. OSTEOPOROSIS



- 7. FRACTURA VERTEBRAL



## Productos relacionados con las patologías

- 1. ESPALDERAS Y CORRECTORES POSTURALES ..... P.27
- 2. FAJAS COSTALES Y BANDAS ..... P.27
- 3. FAJAS DORSOLUMBARES ..... P.27
- 4. FAJAS ABDOMINALES, BANDAS Y BOTONES PARA HERNIAS..... P.28
- 5. FAJAS OSTOMÍA ..... P.28
- 6. FAJAS LUMBARES Y SACRO-LUMBARES ..... P.29
  - SEMIRRÍGIDAS BÁSICAS
  - CADERAS ANCHAS
  - MASAJE LUMBAR
  - USO LABORAL
  - ALTA CONTENCIÓN
  - TALLAS ÚNICAS
  - CONVERTIBLES
  - ABDOMEN PÉNDULO
  - EMBARAZO (VER SECCIÓN MUJER)..... P.85
  - DEPORTE (VER SECCIÓN ESPECIAL DEPORTE)..... P.61
- 7. ÓRTESIS RÍGIDAS Y CORSÉS ..... P.32

## 1 ESPALDERAS Y CORRECTORES POSTURALES



**ORLIMAN  
ACE618**

Transpirable

Con ribetes  
especiales para  
evitar roces en  
la axila

TALLA	PERÍMETRO	CN
1	75-85 cm	191639
2	85-105 cm	191640
3	105-130 cm	191641



**ORLIMAN  
ACV607**

En ocho

Se adapta  
muy bien.  
Diseño discreto

TALLA	PERÍMETRO	CN
1	75-85 cm	191729
2	80-92 cm	191750
3	85-97 cm	191751
4	92-104 cm	191752
5	98-110 cm	191753
6	104-120 cm	191754

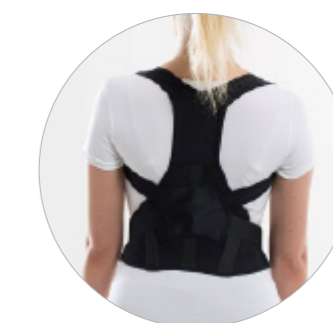

**THUASNE  
EXT 100**

Larga

Abarca hasta  
la cintura

TALLA	ALTURA	CINTURA	CN
Petite	145-170 cm	60-80 cm	0099152
Small	170-190 cm	60-80 cm	0099153
Standard	170-190 cm	80-110 cm	0099154



## 2 FAJAS COSTALES Y BANDAS



**EMO  
FJ341**

TALLA	PERÍMETRO	CN
S	78-85 cm	098554
M	85-100 cm	098555
L	100-115 cm	098556



**EMO  
FJ342**

Con forma  
para el pecho

TALLA	PERÍMETRO	CN
S	78-85 cm	098559
M	85-100 cm	098561
L	100-115 cm	098562



**ACTIMOVE  
COSTA**

Gran tallaje



TALLA	PERÍMETRO	CN
♂ S	62-120 cm	164653
♂ L	100-160 cm	164654
♀ W	65-120 cm	164655



## 3 FAJAS DORSOLUMBARES



**TEYDER  
707FV**

Muy cómoda  
y transpirable



TALLA	PERÍMETRO	CN
S	64-77 cm	098394
M	78-92 cm	098393
L	93-109 cm	098391
XL	110-126 cm	098396
XXL	127-140 cm	098397

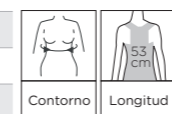

**PRIM  
237  
ELCROSS GOLD**



TALLA	CADERA	CN
S	85-95 cm	076678
M	95-105 cm	076677
L	105-115 cm	076676
XL	115-125 cm	076680
XXL	125-135 cm	076681

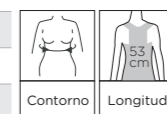

## 4 FAJAS ABDOMINALES, BANDAS Y BOTONES PARA HERNIAS

### 4.1 FAJAS



PRIM  
PRS603BG

3 bandas

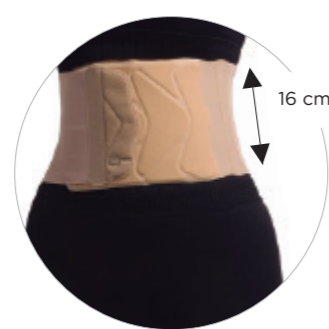

PRIM  
PRS602BG

2 bandas



ACTIMOVE  
ABDOMINAL  
3B

Gran tallaje

TALLA	CINTURA	CN
S	70-90 cm	035900
M	90-110 cm	035907
L	110-130 cm	035908
XL	130-145 cm	035909

TALLA	CADERA	CN
S	70-90 cm	035896
M	90-110 cm	035897
L	110-130 cm	035898
XL	130-145 cm	035899

TALLA	CADERA	CN
S	60-95 cm	098284
M	95-130 cm	035834
L	130-160 cm	087399

### 4.2 BANDAS



PRIM  
COMPACTBAND  
982BG

Banda tubular  
cerrada

TALLA	CADERA	CN
S	85-100 cm	169163
L	100-115 cm	169164

Las fajas sirven para postoperatorio abdominal.

Las bandas para dar contención y sensación de calor.



PRIM  
COMPACTBAND  
983BG

Abierta  
con velcro

TALLA	CADERA	CN
S	75-100 cm	169167
L	100-125 cm	169168

### 4.3 FAJA ESPECIAL HERNIAS



EMO  
FJ183



EMO  
PAD80  
Almohadilla redonda  
para hernia umbilical



EMO  
PAD115  
Almohadilla ovalada  
para hernia abdominal

TALLA	CINTURA	CN
S	65-80 cm	098564
M	80-95 cm	098565
L	95-110 cm	098567
XL	110-125 cm	098568
XXL	125-140 cm	098569



Largo

FORMA	CN
OVALADA	098630
REDONDA	098629

## 5 FAJAS OSTOMÍA



PRIM  
FAJA  
STOMACARE  
P302

PAO  
ADAP

TALLA	CINTURA	IZQ	DCHA
M	80-89 cm	089094	076654
L	90-99 cm	077242	033060
XL	100-109 cm	089015	154633
XXL	110-120 cm	077350	098286

## 6 FAJAS LUMBARES

### 6.1 SEMIRRÍGIDAS BÁSICAS

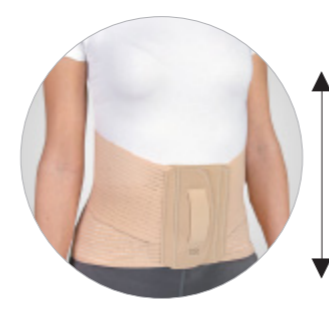

EMO  
FJ100

24 cm



TALLA	CADERA	CN
S	79-85 cm	098571
M	85-91 cm	098572
L	91-99 cm	098753
XI	99-107 cm	098575
XXI	107-115 cm	098576
3XL	115-126 cm	098577

ALTURA: 17 / 26 cm

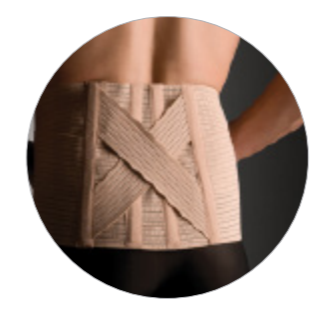

FARMALASTIC  
FAJA  
SACROLUMBAR



TALLA	CINTURA	CN
1	75-90 cm	269118
2	95-105 cm	269126
3	105-120 cm	269134
4	120-130 cm	269142



Contorno

### 6.2 CADERAS ANCHAS



EMO  
LS301

24 cm

TALLA	TROCÁNTER	CN
S	79-85 cm	098578
M	85-91 cm	098579
L	91-99 cm	098580
XI	99-107 cm	098581
XXI	107-115 cm	098583
3XL	115-126 cm	098584



Contorno

### 6.3 MASAJE LUMBAR



ACTIMOVE  
BACK  
SUPPORT

Parte anterior  
muy estrecha  
Con almohadillas  
efecto masaje



TALLA	PERÍMETRO	CN
S/M	74-94 cm	199161
L/XL	94-114 cm	199162

### 6.4 USO LABORAL



PRIM  
PRS625N

PAO  
BAS

TALLA	CADERA	CN
XS	75-85 cm	035980
S	85-95 cm	035977
M	95-105 cm	035976
L	105-115 cm	035975
XL	115-125 cm	035978
XXL	125-135 cm	035988
XXXL	135-150 cm	035989

ALTURA: 15 / 24 cm



ORLIMAN  
LOMBOFIT

PAO  
BAS

TALLA	CADERA	CN
1	75-95 cm	191607
2	95-120 cm	191608
3	120-145 cm	191609

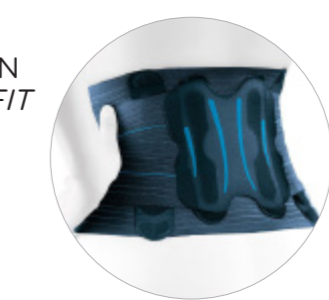

ORLIMAN  
ACE609  
EVOLUTIVE

Especial  
oficina.  
Muy estrecha  
por delante

PAO  
BAS



TALLA	CADERA	CN
1	55-70 cm	191610
2	70-85 cm	191611
3	85-100 cm	191612
4	100-120 cm	191613
5	120-140 cm	191614

ALTURA TRASERA: 26 cm

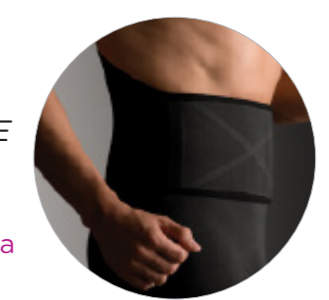

CINFA  
FARMALASTIC

Lumbar  
reforzada

TALLA	CADERA	CN
1	70-90 cm	323006
2	90-120 cm	323014
3	120-140 cm	321141

### 6.5 ALTA CONTENCIÓN

Todas tienen doble tensor.



PRIM  
**ELCROSS  
GOLD 232**  
Faja  
sacro-lumbar  
baja

PAO  
BAS

TALLA	PERÍMETRO	CN
S	85-95 cm	030320
M	95-105 cm	098287
L	105-115 cm	098288
XL	115-125 cm	098289
XXL	125-135 cm	098290
XXL	>135 cm	098291
ALTURA: 19 / 28,5 cm		



DJO  
**IMMOSTRAP**

PAO  
BAS

TALLA	PERÍMETRO	CN
XS	56-68 cm	098922
S	68-82 cm	098923
M	82-98 cm	098924
L	98-116 cm	098925
XL	116-136 cm	098926



PRIM  
**CARE+  
PRS620BG**

PAO  
BAS

TALLA	CADERA	CN
XS	75-83 cm	035952
S	83-91 cm	035953
M	91-99 cm	035954
L	99-107 cm	035955
XL	107-115 cm	035956
XXL	115-123 cm	035958
ALTURA: 17 / 26 cm		



CINFA  
**FARMALASTIC**

TALLA	CINTURA	CN
1	74-99 cm	151367
2	99-127 cm	151368

### 6.6 TALLAS ÚNICAS



PRIM  
**AIRTEX  
OST255**

¡Disponible  
en dos  
colores!

!  
STOCK

TALLA	COLOR	CN
U	BEIGE	187224
U	GRIS	187223
CONTORNO: 85-125 cm		



CINFA  
**FARMALASTIC  
ADVANCE**

!  
STOCK

TALLA	TROCÁNTER	CN
U	75-135 cm	190953



ORLIMAN  
**OA6000**

!  
STOCK

TALLA	CN
U	193427
ALTURA: 16 / 26 cm	



3M  
**FUTURO**

!  
STOCK

TALLA	CN
U	162421

### 6.7 FAJAS CONVERTIBLES: SEMIRRÍGIDA-RÍGIDA-TORACOLUMBAR

Este módulo aporta rigidez a la faja, convirtiéndola en rígida.

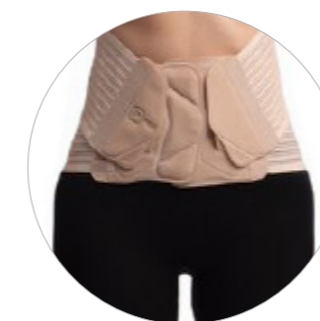

PRIM  
**PRS630BG**

PAO  
BAS

!  
STOCK

TALLA	PERÍMETRO	CN
XS	75-82 cm	035991
S	82-90 cm	035995
M	90-100 cm	035996
L	100-110 cm	035998
XL	110-120 cm	036000
XXL	120-130 cm	036002
ALTURA: 16/26 cm		

+

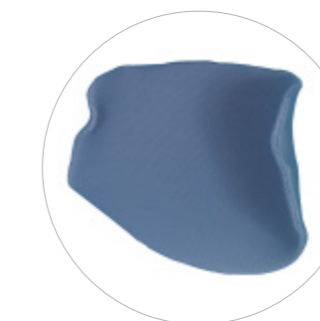

MÓDULO  
**PRS650BG**

PAO  
ADAP

TALLA	PERÍMETRO	CN
XS	75-82 cm	036059
S-M	82-100 cm	036060
L	100-110 cm	036061
XL-XXL	120-130 cm	036062
ALTURA: 30 cm		

+



PRIM  
**PRS636BG OS**

PAO  
ADAP

TALLA	CN
U	036053

Con la faja y los accesorios se pueden cubrir 3 códigos de PAO.

### 6.8 ABDOMEN PÉNDULO



PRIM  
**ELCROSS  
GOLD  
234**

PAO  
ADAP

TALLA	CADERA	CN
S	85-95 cm	086383
M	95-105 cm	076624
L	105-115 cm	086669
XL	115-125 cm	076625
XXL	125-135 cm	098295
ALTURA: 26,5 / 28 cm		



## 7 ÓRTESIS RÍGIDAS Y CORSÉS



PRIM  
SP500  
SPIN AIR

PAO  
ADAP

TALLA	ALTURA	CADERA	CN
S1	51-59 cm	78-93 cm	098303
M1	51-59 cm	90-105 cm	098304
M2	59-68 cm	90-105 cm	098305
L2	59-68 cm	103-120 cm	098306
L3	68-75 cm	103-120 cm	098307

### DE HIPEREXTENSIÓN JEWET

#### FIJO



PRIM  
C34B

PAO  
ADAP

TALLA	CADERA	ALTURA	CN
S	76-83 cm	43-47 cm	098313
M	83-94 cm	45-50 cm	098314
L	94-104 cm	48-54 cm	098315
XL	104-114 cm	53-59 cm	098316

#### BASCULANTE



PRIM  
AVANT  
C35+AV

PAO  
ADAP

TALLA	CADERA	ALTURA	CN
S	76-86 cm	43-47 cm	098308
M	84-98 cm	45-50 cm	098309
L	96-110 cm	48-54 cm	098311
XL	106-120 cm	53-59 cm	098312

## 4 EXTREMIDAD INFERIOR

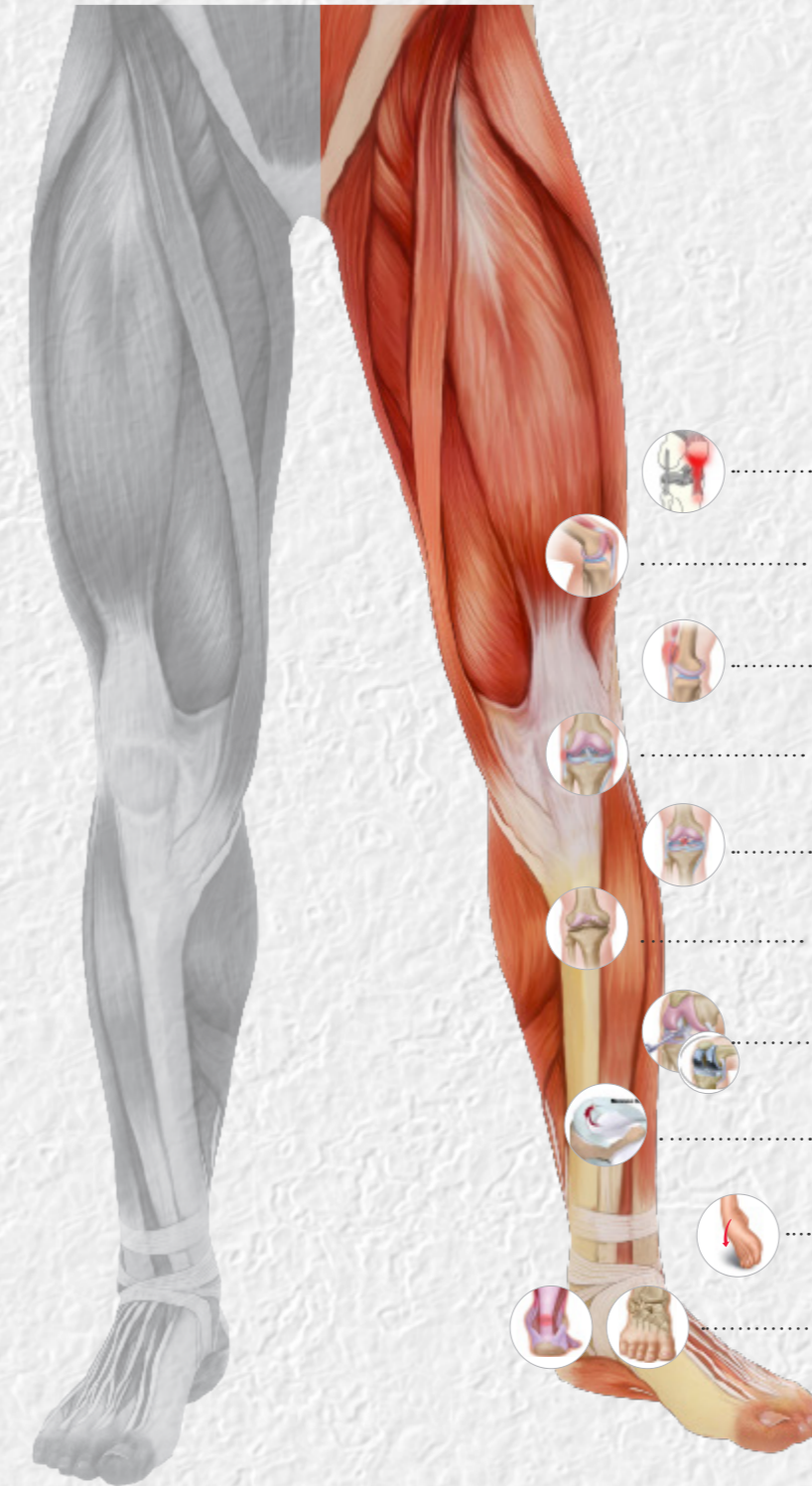

### Patologías

1. HERNIA INGUINAL
2. BURSITIS TROCANTÉREA
3. FATIGA MUSCULAR/HEMATOMA
4. INESTABILIDAD LIGERA DE RODILLA
5. TENDINITIS ROTULIANA
6. CONDROMALACIA ROTULIANA
6. LUXACIÓN DE RÓTULA
7. LIGAMENTOS LATERALES
- 7/8. LIGAMENTOS CRUZADOS
- 7/8. GONARTROSIS
8. CIRUGÍAS
9. MENISGOPATÍAS
10. ESGUINCES DE TOBILLO
11. ROTURA TOBILLO/  
TENDÓN DE AQUILES

### Productos relacionados con las patologías

1. BRAGUEROS Y SUSPENSORIOS ..... P.35
2. (VER SECCIÓN PIE)  
PLANTILLAS - CONFORT -  
TALONERAS..... P.48
3. MUSLERAS ..... P.35
4. RODILLERAS ELÁSTICAS  
DE COMPRESIÓN  
LIGERA..... P.36
- 4.1 TALLAS ÚNICAS ..... P.36
5. CINCHAS INFRAPATELARES... P.37
6. RODILLERAS DE  
COMPRESIÓN MEDIA+  
SOPORTE ROTULIANO+  
FLEJES BLANDOS..... P.37
7. RODILLERAS DE  
COMPRESIÓN MEDIA+  
SOPORTE ROTULIANO+  
FLEJES RÍGIDOS ..... P.38
8. RODILLERAS POST -  
QUIRÚRGICAS..... P.38
9. (VER SECCIÓN PIE)  
TALONERAS..... P.47
10. TOBILLERAS ..... P.40
11. WALKERS Y CUÑAS ..... P.41

# 1 BRAGUEROS Y SUSPENSORIOS



**PRIM 302**  
Slip de contención mujer

TALLA	CINTURA	CN
1	60-64 cm	076747
2	65-69 cm	076748
3	70-74 cm	076749
4	75-79 cm	076750
5	80-84 cm	076751
6	85-89 cm	076753



**PRIM 515**  
Slip de contención hombre Orione

CN 515	TALLA	CINTURA	CN 316
316398	2	76-80 cm	316463
316380	3	81-85 cm	316455
316372	4	86-90 cm	316448
316364	5	91-95 cm	316430
316356	6	96-100 cm	316422
316349	7	101-105 cm	316414
076746	8	106-110 cm	079043



**PRIM 316**  
Slip de contención hombre Orione con apertura delantera. Cierre de velcro  
**Facilita el uso de sistemas de evacuación**



**ACOFAR BRAGUERO INGUINAL**

Izquierdo

CINTURA	CN
80 cm	421396
85 cm	421404
90 cm	421412
95 cm	421420
100 cm	421438
105 cm	421446
110 cm	421453
115 cm	421461



**ACOFAR BRAGUERO INGUINAL**

Ambidiestro

CINTURA	CN
80 cm	421479
85 cm	421487
90 cm	421495
95 cm	421503
100 cm	421511
105 cm	421529
110 cm	421537
115 cm	421545



**ACOFAR BRAGUERO INGUINAL**

Derecho

CINTURA	CN
80 cm	421313
85 cm	421321
90 cm	421339
95 cm	421347
100 cm	421354
105 cm	421362
110 cm	421370
115 cm	421388

# 3 MUSLERAS



**TEYDER 887ML**

Compresión ligera para hematomas musculares leves

TALLA	CINTURA	CN
S	56-60 cm	098401
M	51-55 cm	098399
L	46-50 cm	098398
XL	61-65 cm	098402



! Encontrarás más modelos en la sección de deporte.

#### 4 RODILLERAS ELÁSTICAS DE COMPRESIÓN LIGERA

**SER-SAN LASTICBASS**  
Totalmente abierta. Fácil colocación.  
Con flejes



Perímetro Longitud

TALLA	PERÍMETRO	CN
U	22-26 cm	099323

**ACTIMOVE** Rótula cerrada  
**ACTIMOVE** Rótula abierta  
Flejes muy flexibles



CN	TALLA	PERÍMETRO	TALLA	CN
199152	S	31-36 cm	S	199156
199153	M	36-41 cm	M	199157
199154	L	41-46 cm	L	199159
199155	XL	46-52 cm	XL	199160

#### 5 CINCHAS INFRAPATELARES

**EMO SP515**



TALLA	CN
U	098585

**ORLIMAN PATEL'R**



TALLA	CN
U	191678

**PRIM NEOPRAIR NPOS132**



TALLA	CN
U	190450

**CINFA FARMALASTIC INNOVA**  
Rodillera con banda infrapatelar



TALLA	PERÍMETRO	CN
P	30-35 cm	150316
M	35-40 cm	150317
G	40-45 cm	150319

#### 6 RODILLERAS DE COMPRESIÓN MEDIA + SOPORTE ROTULIANO + FLEJES BLANDOS

**CINFA FARMALASTIC FINANCIADA**



TALLA	PERÍMETRO	CN
P	24-29 cm	441402
M	30-35 cm	441410
G	36-41 cm	441428
EG	42-47 cm	441436

**EMO STP110**  
Strapín de rodilla  
Cinta elástica Muy versátil



TALLA	CN
U	098544

**ORLIMAN ACE 802**  
24 cm



TALLA	PERÍMETRO	CN
1	32-36 cm	198160
2	36-41 cm	198161
3	41-48 cm	198162

**CINFA FARMALASTIC INNOVA**  
Flejes muy flexibles



TALLA	PERÍMETRO	CN
P	30-34 cm	158426
M	34-37 cm	158427
G	37-40 cm	158429

**PRIM AQTIVO SPORT P701**



TALLA	CONTORNO	CN
S	32-35 cm	188365
M	36-39 cm	188366
L	40-46 cm	188368
XL	47-52 cm	190440

**ACTIMOVE GENUOTION**



TALLA	CONTORNO	CN
XXS	35-38 cm	098228
XS	38-41 cm	911385
S	41-44 cm	047536
M	44-47 cm	098229
L	47-50 cm	046513
XL	50-53 cm	098230
XXL	53-56 cm	043294

**DJO GENUFORCE**



TALLA	CONTORNO	CN
XS	37-40 cm	098927
S	40-43 cm	098928
M	43-46 cm	098929
L	46-49 cm	098930
XL	49-52 cm	098931
XXL	52-55 cm	098932
3XL	55-58 cm	098933

**MC DAVID 5116**



TALLA	CONTORNO	CN
S	30-36 cm	036164
M	36-38 cm	036165
L	38-43 cm	036166
XL	43-51 cm	036167

#### 4.1 TALLAS ÚNICAS

**3M FUTURO COMFORT 76586**  
Aporta calor



TALLA	PERÍMETRO	CN
S	30,5-36,8 cm	158521
M	36,8-43,2 cm	158522
L	43,2-49,5 cm	158523
XL	49,5-55,2 cm	172785

**3M FUTURO CLASSIC 46163**  
Flejes muy blandos



TALLA	PERÍMETRO	CN
S	30,5-36,8 cm	208963
M	36,8-43,2 cm	208962
L	43,2-49,5 cm	208961

**CINFA FARMALASTIC ADVANCE ALL IN ONE**  
Con rodete de silicona que permite intercambiar su posición



TALLA	PERÍMETRO	CN
U	32-50 cm	190960

**ORLIMAN OA8000 ONE AIR**  
Tejido ultratranspirable



TALLA	RANGO	CN
U	29-56 cm	193424

**ORLIMAN ROTULIG ACE807**



TALLA	PERÍMETRO	CN
1	29-33 cm	191649
2	33-37,5 cm	191651
3	37,5-42 cm	191652
4	42-47 cm	191653
5	47-53 cm	191654
6	53-58 cm	191655

**ORLIMAN ROTULIG'R ACE808**



TALLA	PERÍMETRO	CN
1	28-31 cm	191656
2	31-34 cm	191657
3	34-37 cm	191658
4	37-40 cm	191659
5	40-43 cm	191660
6	43-46 cm	191661
7	46-49 cm	191662

Todas estas rodilleras han sido propuestas por sus respectivos fabricantes para que entren por PAO. Aunque, por el momento, aún no están confirmadas y habrá que esperar a futuras actualizaciones en la lista de códigos.

Encontrarás más modelos en la sección de deporte.

Encontrarás más modelos en la sección de deporte.

## 7 RODILLERAS DE COMPRESIÓN MEDIA + SOPORTE ROTULIANO + FLEJES RÍGIDOS



MC DAVID 421

PAO BAS

TALLA	CONTORNO	CN
S	30-36 cm	085884
M	36-38 cm	085885
L	38-43 cm	085887
XL	43-51 cm	085888
XL	51-56 cm	085889



DJO PLAYMAKER EXPERT WRAP

Abierta  
Fácil colocación

PAO BAS

TALLA	CONTORNO	CN
XS	33-39 cm	098941
S	39-47 cm	098942
M	47-53 cm	098943
L	53-60 cm	098944
XL	60-67 cm	098945
XXL	67-75 cm	098946
XXXL	75-81 cm	098948



DJO STABILAX

PAO BAS

TALLA	PERÍMETRO	CN
XS	35-38 cm	098934
S	38-42 cm	098935
M	42-46 cm	098936
L	46-49 cm	098937
XL	49-53 cm	098938
XXL	53-57 cm	098940



ORLIMAN ROTULIG STAB ACE809

Incluye 2 juegos de flejes de distinta dureza.

PAO BAS

TALLA	PERÍMETRO	CN
1	26-29 cm	191663
2	29-32 cm	191664
3	32-35 cm	191665
4	35-38 cm	191666
5	38-41 cm	191667
6	41-44 cm	191669
7	44-47 cm	191670

## 8.2 CON ARTICULACIÓN GRADUABLE EN FLEJO-EXTENSIÓN

### 8.2.A Policéntrica



DJO PLAYMAKER II

PAO ADAP

TALLA	PERÍMETRO	CN
XS	33-39 cm	098953
S	39-47 cm	098955
M	47-53 cm	098956
L	53-60 cm	098957
XL	60-67 cm	098958
XXL	67-75 cm	098959
3XL	75-81 cm	098960

### 8.2.B Monocéntrica



DJO X-ACT ROM LITE

PAO ADAP

TALLA	PERÍMETRO	CN
U	<76 cm	099360

Diferencias entre articulaciones:  
**Monocéntrica:** con eje sencillo sin control de postura.

**Policéntrica:** con ejes de rotación múltiples que permiten mayor amplitud de movimientos.

## 8 RODILLERAS POST-QUIRÚRGICAS

### 8.1 INMOVILIZADORAS

#### 8.1.A Rígidas, sin articulación



ORLIMAN GENU'R

Fácil colocación y perfecto ajuste

PAO BAS

PAO BAS

TALLA	MEDIDAS	50 cm	60 cm
1	32-34 cm	191679	191681
2	34-36 cm	191680	191682

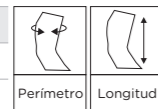

DJO IMMO AT43V

De paneles

PAO BAS

TALLA	ALTURA	CN
PED	NIÑO	098949
40cm	<1,60 cm	098950
50cm	1,60-1,90 cm	098951
60cm	> 1,90 cm	098952

#### 8.1.B Con articulación policéntrica sin graduación de flexoextensión



TEYDER 236RD

Estabilización de ligamentos cruzados

PAO ADAP

PAO BAS

MC DAVID 429

PAO ADAP

TALLA	PERÍMETRO	CN
S	33-35 cm	098405
M	36-38 cm	098404
L	39-42 cm	098403
XL	42-45 cm	098406



TALLA	PERÍMETRO	CN
S	30-36 cm	085906
M	36-38 cm	085907
L	38-43 cm	085908
XL	43-51 cm	085909
XXL	51-56 cm	085910

Encontrarás más modelos en la sección de deporte.

**Patología**

**ESGUINCE DE TOBILLO:**  
Los esguinces pueden ser de grado I, II o III según la gravedad. Dependerá de la cantidad de fibras rotas y de las estructuras afectadas.

**RECOMENDACIONES:**

**Grado I:** distensión ligera de fibras. Buscaremos una sujeción simple + AINE tópico + AINE oral.

**Grado II-III:** rotura de fibras total o parcial, hematoma/inflamación y dolor o imposibilidad de apoyar el pie. Buscaremos estabilización y /o inmovilización + Ejercicios de propiocepción + Magnetoterapia + Diatermia.

10.1 GRADO I

**CINFA FARMALASTIC FINANCIADA**  
Un básico

TALLA	PERÍMETRO	CN
P	17-20 cm	441360
M	21-24 cm	441378
G	25-28 cm	441386
EG	29-32 cm	441394

**ACTIMOVE**  
Tejido elástico muy agradable

TALLA	PERÍMETRO	CN
S	18-21 cm	199163
M	21-24 cm	199164
L	24-27 cm	199165
XL	27-30 cm	199167

**EMO STPO80**  
Strapín de tobillo  
Cinta elástica Vendajes en 8

TALLA	CN
U	098543

**ORLIMAN ACE 902**  
Elástica ajustable  
Colocación intuitiva

TALLA	PERÍMETRO	CN
1	17-20 cm	198170
2	20-23 cm	198171
3	23-26 cm	198172

**FUTURO TOBILLERA CLASSIC 47874**

TALLA	PERÍMETRO	CN
S	17,8-20,3 cm	200667
M	20,3-22,9 cm	336388
L	22,9-25,4 cm	200675

**ORLIMAN CHEVLIG ACE 904**  
Tipo calcetín con cinta de ajuste extraíble

TALLA	PERÍMETRO	CN
1	<19 cm	191687
2	19-20 cm	191688
3	20-23 cm	191689
4	23-25 cm	191690
5	>25 cm	191691

**CINFA FARMALASTIC INNOVA**  
Cinta elástica Vendajes en 8

TALLA	CONTORNO	CN
P	20-22 cm	158661
M	22-24 cm	158662
G	24-26 cm	158663
EG	26-28 cm	158664

**CINFA FARMALASTIC ADVANCE ESTABILIZADORA CROSSING**  
Talón abierto

TALLA	CONTORNO	CN
U	17-30 cm	190961

10.2 GRADO II-III

**DJO SPEED PRO** Un básico

**DJO AIRCAST AIRSPORT** Al tener lados, se adapta mucho mejor

**ORLIMAN MEMOFORCE ACV901** Con espuma visco

**THUASNE LIGASTRAP**

**DJO FUSIOLIGHT**

TALLA	PERÍMETRO	CN
XXS	23-25 cm	098961
XS	25-28 cm	098963
S	28-30 cm	098964
M	30-33 cm	098965
L	33-36 cm	098966
XL	36-38 cm	098967
XXL	38-41 cm	098968
XXXL	41-43 cm	098969

TALLA	Nº CALZADO	IZQ	DCHA
XS	30-34	098974	098979
S	35-38	098975	098980
M	39-42	098976	098981
L	43-47	098977	098982
XL	>47	098978	098983

TALLA	ALTURA	CN
1	<160 cm	191755
2	>160 cm	191756

TALLA	IZQ	DCHA
ADULTO	099270	099269

TALLA	LONGITUD	CN
PED	17 cm	098971
S-M	23 cm	098972
L-XL	25,5 cm	098973

11 WALKERS

11.1 ARTICULADO

**Largo**

**ORLIMAN BOTIMED ACV903**

TALLA	Nº CALZADO	CN
1	<37	191762
2	<41	191763
3	<45	191764

**Corto**

**DJO MAXTRAX ROM**

TALLA	Nº CALZADO	CN
XS	<36	098984
S	36-39	098985
M	40-44	098986
L	44-46	098987
XL	>46	098989

11.2 FIJO

**Largo**

**ORLIMAN BOTIMED ACV904**

TALLA	Nº CALZADO	CN
1	32-38	198183
2	38-42	198185
3	42-46	198186

**Corto**

**ORLIMAN ACV905**

TALLA	CN
1	198187
2	198188
3	198189

11.3 AIRE

**Largo**

**THUASNE XLR8**

TALLA	Nº CALZADO	CN
1	<36	099263
2	36-40	099264
3	40-44	099265
2	44-47	099266

**Corto**

**DJO AIR SELECT**

TALLA	Nº CALZADO	CN
XS	<35	098990
S	35,5-39,5	098991
M	39,5-43	098992
L	43-47	098993
XL	>46	098994

**DJO CUÑAS**

TALLA	CN
U	099126

Con un walker fijo y las cuñas podemos dar la misma cobertura que con un walker articulado.

Encontrarás más modelos en la sección de deporte.

# 5 PIE

## Patologías



## Productos relacionados con las patologías

1. ZAPATOS POST-OPERATORIOS
  - PLANO .....P.46
  - EN TALO.....P.46
  - DESCARGA DE TALÓN .....P.46
  - ZAPATOS PARA YESO .....P.46
  - ZAPATOS PARA PIE DIABÉTICO/ÚLCERAS.....P.46
2. ALMOHADILLAS ..... P.47
3. TALONERAS..... P.47
4. PLANTILLAS
  - DOLOR.....P.48
  - CONFORT .....P.48
  - OLOR.....P.48
  - ALZAS.....P.48
  - ZAPATO ABIERTO/SANDALIA/BODAS.....P.49
5. JUANETE: PROTECTORES, SEPARADORES Y CORRECTORES ..... P.49
6. DEDOS EN GARRA: CORRECTORES Y PROTECTORES.....P.50
7. RESTO DE SILICONAS Y PRODUCTOS PARA EL PIE..... P.51
8. ANTIEQUINOS..... P.52
9. ZAPATOS
  - PIE DIABÉTICO..... P.52
  - PALA ELÁSTICA..... P.52
  - GRAN CAPACIDAD ..... P.53
10. ZUECOS
  - CON AGUJEROS..... P.54
  - TOTALMENTE CERRADOS..... P.54
  - ZUECO MEDICAL..... P.55
  - ESTAMPADOS ORIGINALES..... P.55





### Patología



**METATARSALGIA:**  
Inflamación del tejido que rodea las cabezas metatarsales provocando dolor, debido a una excesiva presión en la zona. El uso de tacones, pies cavos o determinados impactos pueden ser la causa.

**RECOMENDACIONES:** almohadillas o plantillas con bóvedas retrocapitales

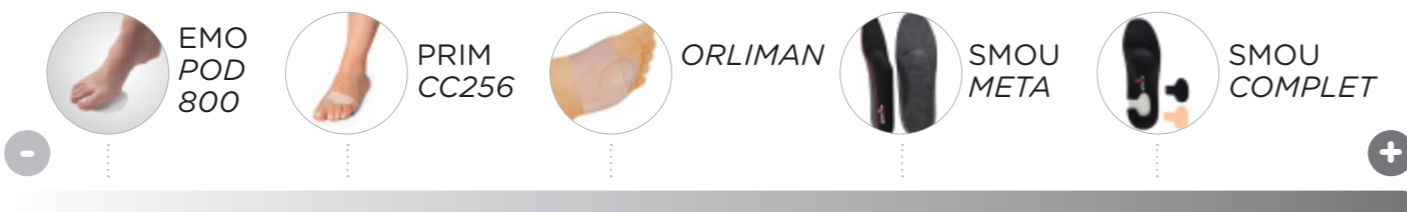

### Patología



**FASCITIS PLANTAR:**  
Inflamación de la banda de tejido elástico de la planta del pie. El dolor suele producirse en el arco interno y sobre todo en el talón, siendo más intenso por las mañanas, por el acortamiento de la musculatura plantar.

**RECOMENDACIONES:** aplicar frío, cuantas más veces mejor. Con PRIM PEDIROLLER, una vez congelado, podrás masajear la planta del pie, en frío.

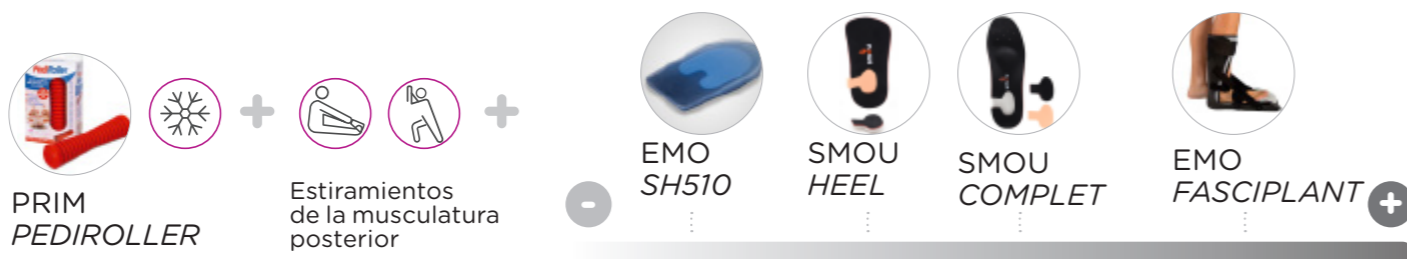

### Patología



**ESPOLÓN CALCÁNEO:**  
Calcificación que se produce en el tendón de la fascia plantar en su inserción en el calcáneo (talón). La inflamación de la misma es lo que produce el dolor.

**RECOMENDACIONES:**

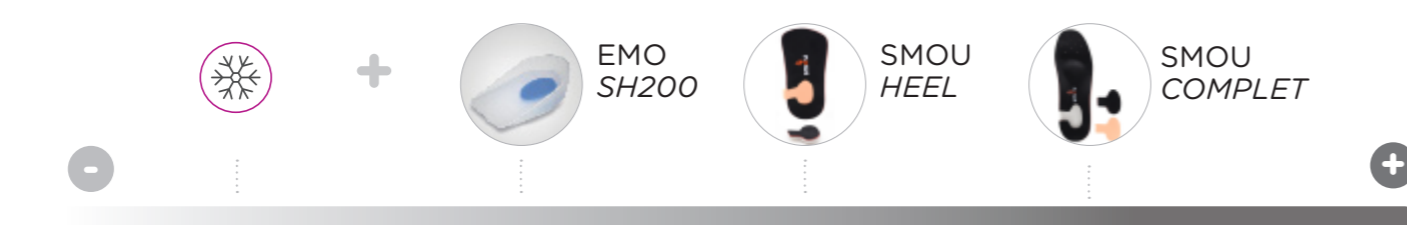

### Patología



**JUANETE:**  
Desviación del primer metatarso a nivel de la articulación, produciendo deformidades y protuberancias del hueso que pueden llegar a limitar el movimiento e impedir una normal deambulación.



### Patología



**DEDOS EN GARRA:**  
Deformidad que afecta a varios dedos del pie por la hiperextensión de la articulación metacarpo-falángica acompañada de flexión de las articulaciones interfalángicas proximal y distal.

**PARA DEDOS CON MOVILIDAD (SE ESTIRAN)**



**PARA DEDOS SIN MOVILIDAD (NO SE ESTIRAN)**

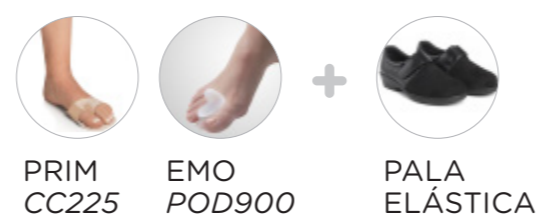

**SMOU COMPLET**  
Metatarsalgia  
Fascitis plantar  
Espolón calcáneo

Plantillas con base de resina rígida 3/4, gel de espuma de látex sintético, memory foam, forro de micro-fibra absorbente, pieza extraíble e intercambiable en el talón y bóveda retrocapital / metatarsal.

Beneficios	Para quién es?	Tipo de pisada/pies	Tipo de calzado
<ul style="list-style-type: none"> <li>Amortiguación</li> <li>Descarga metatarsal</li> <li>Sujeción del arco interno</li> <li>Descarga del talón</li> <li>Mejora la pisada y la postura</li> <li>Equilibra la estructura</li> </ul>	Tallas: de 37 al 46 > 15 años	Todos	<ul style="list-style-type: none"> <li>Botas de seguridad</li> <li>Calzado con capacidad* (plantilla extraíble)</li> </ul>



**SMOU HEEL**  
Fascitis plantar  
Espolón calcáneo  
Tendinitis aquiles

Taloneras largas con base de resina, látex, memory foam, forro de microfibras absorbente y pieza extraíble e intercambiable en talón.

Beneficios	Para quién es?	Tipo de pisada/pies	Tipo de calzado
<ul style="list-style-type: none"> <li>Amortiguación</li> <li>Sujeción del arco interno</li> <li>Descarga del talón</li> <li>Elevan el talón 1,5cm</li> </ul>	Tallas: de 36 al 47 Niños y adultos	Todos	<ul style="list-style-type: none"> <li>Cualquiera</li> <li>Incluso sandalias con dedo</li> </ul>



**SMOU HALLUX**  
Juanete  
Pie pronador

Plantillas moldeadas con arco interno de compensación, doble refuerzo en el primer dedo y bóveda retrocapital/metatarsal. Base entera de resina, memory foam y forro de microfibra absorbente.

Beneficios	Para quién es?	Tipo de pisada/pies	Tipo de calzado
<ul style="list-style-type: none"> <li>Descarga metatarsal</li> <li>Correcta estructuración del pie pronado</li> <li>Limitación del movimiento del primer metatarso</li> </ul>	Tallas: de 35 al 46 > 15 años	Todos* Pie pronado	<ul style="list-style-type: none"> <li>Cualquiera</li> <li>Botas de seguridad</li> <li>Calzado de verano apto para plantillas</li> </ul>



**SMOU META**  
Metatarsalgia

Plantillas de gel de espuma de látex sintético, memory foam y forro de microfibra absorbente. Con bóveda retrocapital/metatarsal.

Beneficios	Para quién es?	Tipo de pisada/pies	Tipo de calzado
<ul style="list-style-type: none"> <li>Descarga metatarsal/alivio en la base de la almohadilla.</li> <li>Amortiguación/confort.</li> </ul>	Tallas: de 35 al 46 > 15 años Pie Geriátrico	Todos* Si no necesitan corrección	<ul style="list-style-type: none"> <li>Botas de seguridad</li> <li>Calzado con capacidad* (plantilla extraíble)</li> </ul>



**SMOU COMFORT**  
Amortiguación para:  
- Pies cansados  
- Botas de seguridad  
- Largos turnos de pie

Plantillas de gel de espuma de látex, memory foam y forro de microfibra absorbente.

Beneficios	Para quién es?	Tipo de pisada/pies	Tipo de calzado
<ul style="list-style-type: none"> <li>Amortiguación</li> <li>Comodidad</li> </ul>	Tallas: de 36 al 47 Niños y adultos	Todos* Si no necesitan corrección	<ul style="list-style-type: none"> <li>Cualquiera</li> <li>Botas de seguridad</li> <li>Calzado con capacidad* (plantilla extraíble)</li> </ul>



**SMOU DAILY**  
Molestias en almohadilla y arco interno  
Ideal zapatos estrechos

Plantillas cortas (3/4) de gel de espuma de látex sintético, memory foam y forro de microfibra absorbente. Con bóveda retrocapital/metatarsal.

Beneficios	Para quién es?	Tipo de pisada/pies	Tipo de calzado
<ul style="list-style-type: none"> <li>Descarga metatarsal/alivio en la base de la almohadilla.</li> <li>Amortiguación/confort.</li> </ul>	Tallas: de 35 al 41 > 15 años Pie Geriátrico	Todos* Si no necesitan corrección	<ul style="list-style-type: none"> <li>Cualquiera</li> <li>Zapatos de mujer estrechos</li> <li>Sandalias con o sin dedo</li> </ul>

# 1 ZAPATOS POST-OPERATORIOS

## 1.1 PLANO



PRIM  
PS100

Nº CALZADO	CN
33-35	076982
36-38	076980
39-40	076544
41-42	076979
43-45	076981
46-48	077682

## 1.2 EN TALO



PRIM  
PS200

Para operaciones en antepié

Nº CALZADO	CN
33-35	076988
36-38	076986
39-40	076985
41-42	076983
43-45	076987

## 1.3 TALÓN INVERTIDO



DJO  
PODAHEEL

Para operaciones en retropié

TALLA	Nº DE PIE	CN
S	36-38	099303
M	39-42	099304
L	43-45	099305
XL	45-48	099306

## 1.4 PARA YESO



ORLIMAN  
ACP932

TALLA	Nº CALZADO	CN
1	35-37	191157
2	38-40	191158
3	41-43	191159



FLEXOR  
TAKO

TALLA	Nº PIE	CN
P	PED	183772
M	MUJER	183764
G	HOMBRE	183756

## 1.5 ZAPATOS PARA PIE DIABÉTICO/ÚLCERAS



ORLIMAN  
ACP933

TALLA	Nº CALZADO	CN
0	33-35	191160
1	36-38	191161
2	39-40	191162
3	41-42	191164
4	43-45	191165

# 2 ALMOHADILLAS



ORLIMAN  
ACP 920

Banda con elevación metatarsal (par)

Con bóveda retrocapital

TALLA	Nº CALZADO	CN
S	35-37	190624
M	38-40	190623
L	41-43	190625



EMO  
POD 800  
Silicona

! STOCK

TALLA	CN
U	098586



PRIM  
CC256

Protector plantar con almohadilla

TALLA	CN
XS	152976
S	196294
L	196296



PRIM  
CC320

Protector elástico almohadillado

Triple protección: corrige, protege y acolcha

TALLA	CN
S	155472
L	155474



ORLIMAN  
ACP921

Protector de antepié (par)

TALLA	CN
S	190598
M	190599
L	190620



CINFA  
FARMALASTIC  
FEET

Para calzado cerrado

TALLA	PIE	CN
P	36-38	201280
M	39-41	201281
G	42-45	201282



CINFA  
FARMALASTIC  
FEET

Para calzado abierto

! STOCK

TALLA	CN
U	162117

# 3 TALONERAS

Una patología citada en el tema de extremidad inferior es la trocanteritis. Cualquiera de estas taloneras amortiguará los impactos recibidos y ayudará a minimizar las molestias.

Se usa como cuña. Para meniscopatías o torceduras recurrentes.



SMOU  
HEEL

Con piezas intercambiables

TALLA	Nº CALZADO	CN
S	36-37-38	099447
M	39-40-41	099448
L	42-43-44	099449
XL	45-46-47	099450

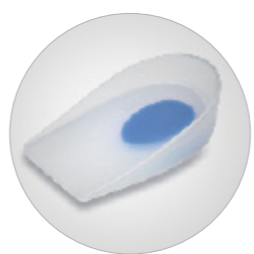

EMO  
SH200

Descarga lateral

TALLA	Nº CALZADO	CN
S	34-36	099447
M	37-38	099448
L	40-42	099449
XL	43-45	099450



EMO  
SH300

Descarga central

TALLA	Nº CALZADO	CN
S	34-36	098587
M	37-38	098588
L	40-42	098589
XL	43-45	098591



EMO  
SH510

Forrada, absorbente

TALLA	Nº CALZADO	CN
S	34-36	098592
M	37-38	098593
L	40-42	098594
XL	43-45	098595



EMO  
SH600  
TALONERA  
pronosupinadora

Con prescripción médica

TALLA	Nº CALZADO	CN
S	34-36	098596
M	37-38	098597
L	40-42	098598
XL	43-45	098599



## 4 PLANTILLAS

### 4.1 PLANTILLAS PARA DOLOR



**SMOU COMPLET**  
Metatarsalgia  
Fascitis plantar  
Espolón calcáneo



TALLA	CN
37-38	197045
39-40	197047
41-42	197048
43-44	197049
45-46	205779



**SMOU HALLUX**  
Juanete  
Pie pronador



TALLA	CN
35-36	037231
37-38	037230
39-40	037228
41-42	037227
43-44	037226
45-46	037225



**SMOU META**  
Metatarsalgia  
Pie geriátrico



TALLA	CN
35-36	037242
37-38	037241
39-40	037239
41-42	037238
43-44	037237
45-46	037236

### 4.2 PLANTILLAS CONFORT



**SMOU COMFORT**  
Pies cansados  
Botas de seguridad  
Largos turnos de pie  
Amortiguación y confort



TALLA	CN
36-37	201693.4
38-39	201694.1
40-41	201695.8
42-43	201696.5
44-45	201697.2
46-47	201698.9



**SMOU DAILY**  
Plantillas de 3/4 ideal para calzado estrecho  
Soporte del arco interno  
Descarga metatarsal



TALLA	CN
35-36-37	037223
38-39	037222
40-41	037221



**CINFA DAY**  
Plantillas de gel

TALLA	CN
36-39	187504
40-43	187505
44-47	187506

### 4.3 PLANTILLAS PARA OLOR

### 4.4 ALZAS PLANTILLA ENTERA



**CINFA PRO**  
Actividad intensa  
Amortiguación de impactos

TALLA	Nº de pie	CN
S	36-39	187507
M	40-43	187508
L	44-47	187509



**PRIM CC297**  
Plantillas carbón total "odor control"  
Recortables del 35 al 45

TALLA	CN
U	177215



**SMOU RISE**  
0,5 cm

Nº CALZADO	CN IZQ	CN DCHA
35-36	037194	037202
37-38	037193	037200
39-40	037192	037209
41-42	037191	037208
43-44	036532	037207
45-46	037240	037195



**SMOU RISE**  
1 cm

Nº CALZADO	CN IZQ	CN DCHA
35-36	037214	037220
37-38	037213	037219
39-40	037209	037218
41-42	037208	037217
43-44	037207	037216
45-46	037204	037215

! Encontrarás más modelos en la sección de deporte.

### 4.5 PLANTILLAS ZAPATO ABIERTO/BODAS



**ORLIMAN ACP927**  
Protector de talón (par)

TALLA	CN
U	190911



**ORLIMAN ACP929**  
Talonera

TALLA	CN
U	190913



**ORLIMAN ACP925**  
Almohadilla antepié  
Adhesivas

TALLA	CN
U	190909



**ORLIMAN ACP926**  
Almohadilla antepié  
Adhesivas con corte para sandalia

TALLA	CN
U	190910



**PRIM CG0366**  
Tacones muy altos

TALLA	CN
35-40	195549



**PRIM CG0367**  
Tacones muy altos

TALLA	CN
35-40	195548



**PRIM CG0368**  
Zapato abierto

TALLA	CN
35-40	195547



**PRIM CG0369**  
Zapato plano

TALLA	CN
35-40	195546



**CINFA FARMALASTIC FEET**  
Almohadilla especial tacones

TALLA	CN
U	170666

## 5 JUANETE: PROTECTORES, SEPARADORES Y CORRECTORES



**PRIM CG2101**  
Separador del primer dedo  
Con anillo

TALLA	CN
M	186708
L	186709



**PRIM CC218**  
Separador del primer dedo

TALLA	CN
S	156332
M	156333
L	156334



**PRIM CC206**  
Separador de dedos  
Extrafino

TALLA	CN
S	155815
M	155816
L	155817



**PRIM CG1801**  
Protector de juanete con anillo

TALLA	CN
U	166449



**PRIM CG1901**  
Protector juanete de sastre  
Para el quinto dedo

TALLA	CN
U	166448



PRIM  
CC450  
Corrector  
de juanete  
diurno

LADO	CN
DCHO	198064
IZQ	198063



PRIM  
CC264  
Protector  
de juanete

TALLA	CN
S	251978
L	251977



CINFA  
FARMALASTIC  
FEET

Doble acción:  
Protector de  
juanete y  
plantar

TALLA	Nº PIE	CN
P	36-38	159508
M	39-41	159510
G	41-43	159511



CINFA  
FARMALASTIC  
FEET

Doble acción:  
Corrector +  
protector  
plantar

TALLA	ANTEPIÉ	IZQ	DCHO
P	20-21,5	170835	170667
M	21,5-23	170836	170668
G	23-24,5	170838	170669



ORLIMAN  
ACP943  
Corrector  
diurno  
y nocturno

PERÍMETRO MAX	CN
30cm	191123



TALLA	Nº PIE	DCHO	IZQ
S/M	35-40	098600	098602
L/XL	40-45	098601	098603



PRIM  
CC322  
Faja  
Metatarsal

TALLA	CONTORNO	CN
S	19-21 cm	155706
M	21-23 cm	155707
L	23-25 cm	155708



CINFA  
FARMALASTIC  
FEET

Especial  
dedos  
montados

TALLA	CN
U	162118

## 6 DEDOS EN GARRA: CORRECTORES Y PROTECTORES

Para frenar el avance de la flexión de los dedos, se recomienda usar plantillas o almohadillas con bóveda metatarsal pronunciada, ya que al presionar el arco, los dedos se estiran.



PRIM  
CC225  
Protector de  
antepié con  
almohadilla  
  
Ideal para callos  
en las yemas de  
los dedos

TALLA	CN
S	162511
L	162545



EMO  
POD900  
  
Para segundo  
dedo en garra  
con separador  
interdigital

TALLA	DCHO	IZQ
S/M	098604	098606
L/XL	098605	098607



PRIM  
CG0801  
Ratoncito  
con anillo  
de sujeción

TALLA	CN
U	166437



CINFA  
FARMALASTIC  
FEET

Ratoncitos  
subdigitales  
  
Forrados

T/U	CN
SEÑORA	165745
CABALLERO	165747

## 7 RESTO DE SILICONAS Y PRODUCTOS PARA EL PIE



PRIM  
CC213  
Protector  
de talón  
  
Autoadhesivo

TALLA	CN
U	162537



PRIM  
CG1701  
Anillo  
protector  
para el 5º  
dedo

TALLA	CN
U	166460



PRIM  
CC227  
Dedil  
protector

TALLA	CN
S	156345
L	156346



PRIM  
CC267  
Dedil con  
tejido  
elástico

TALLA	CN
S	266658
L	266657

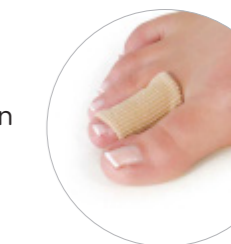

PRIM  
CG1201  
Anillos  
digitales  
con tejido  
elástico

TALLA	CN
S-M	166427
L-XL	166428



CINFA  
FARMALASTIC  
FEET

Protector  
tubular  
  
Callos dorsales

TALLA	CONTORNO	CN
P	22 mm	305091
M	25 mm	305090
G	33 mm	304479



CINFA  
FARMALASTIC  
FEET

Protector-  
separador  
  
Callos Interdigitales

TALLA	CN
U	162119



CINFA  
FARMALASTIC  
FEET

Protector de callos  
  
Callos pulpares.  
Uñas encarnadas

TALLA	CONTORNO	CN
P	23 mm	305092
M	26 mm	305093
G	36 mm	305095



CINFA  
FARMALASTIC  
FEET

Protector  
  
Para grietas  
en el talón

TALLA	CN
U	165741



PRIM  
CC327  
Parches  
adherentes  
callos  
"aqua"

TALLA	CN
U	161334



PRIM  
CC329  
Lámina  
recortable  
adherente  
"aqua"  
  
Ideal  
anti-roces

MEDIDAS	CN
9,5x9,5 cm	161336



PRIM  
CC249  
Lámina fieltro  
recortable  
adherente  
  
Evita roces  
y presiones

MEDIDAS	CN
22x7 cm	157937



PRIM  
CC332  
Protector  
tibial  
"aqua"  
  
Muy útil  
con botas  
de esquí

MEDIDAS	CN
9,5x9,5 cm	161332



3M  
Nexcare  
Active  
tape  
  
Anti-roces  
universal

MEDIDAS	CN
2,5x4,5 cm	196906

Complemento para tratar la fascitis plantar. Se puede congelar.



PRIM  
PEDIROLLER  
CAR085  
  
Para masajear  
la planta  
del pie

ENVASE	CN
UNIDAD	077723



FLEXOR  
9018  
  
Para  
dismetrías

TALLA	CN
MUJER (T/2)	376798
HOMBRE (T/3)	376806



3M  
FUTURO  
Soporte  
diurno  
para fascitis  
plantar

TALLA	CN
U	189733

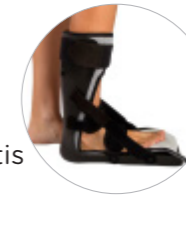

EMO  
PS300  
FASCIPLAN

TALLA	CN
U	098628



3M  
FUTURO

TALLA	CN
U	189732



PRIM  
TOE  
LOOPS  
  
Banda de  
inmovilización  
de dedos

ENVASE	MEDIDAS	CN
5 uds	2,5x7 cm	039186
	2,5x10 cm	036001

## 8 ANTIEQUINOS



EMO  
AFO100  
ANTIEQUINO

Media planta

PAO  
ADAP

TALLA	Nº PIE	DCHO	IZQ
S	31-35	098609	098614
M	36-40	098610	098613
L	41-45	098611	098612



PRIM  
AIRMED  
ATX11  
BANDA  
PLANTAR

PAO  
BAS

TALLA	CONTORNO	DCHO	IZQ
S	17-21 cm	098320	078225
M	21-25 cm	098317	098321
L	25-29 cm	098318	098322



PRIM  
AIRMED  
ATX01

PAO  
BAS

TALLA	CONTORNO	CN
XS	13-17 cm	076587
S	17-21 cm	076576
M	21-25 cm	076586
L	25-29 cm	076585



## 9 ZAPATOS

### 9.1 ESPECIAL PIE DIABÉTICO



ORLIMAN  
OF1600  
CALZADO  
RHUYS

PAO  
BAS

TALLA	CN
36	098852
37	098853
38	098854
39	098856
40	098857
41	098858
42	098859
43	098860
44	098861
45	098862
46	098864

#### Características:

- Zapato gran confort con sistema de cierre ajustable para una perfecta adaptación al tamaño del pie.
- Sin costuras en el antepié, ideal para pies diabéticos.
- Plantilla extraíble que permite el uso de una plantilla ortopédica.
- Tejido de nido de abeja para una óptima transpiración y una excelente sujeción del pie.
- Repelente al agua.
- Tejido exterior ligeramente elástico para mejor adaptación a las deformidades de los dedos.

Color: negro

#### Para:

- Dedos en garra, martillo
- Durezas, callos
- Hallux valgus-Juanetes
- Enfermedades de la uña
- Pie reumático y/o artrítico
- Metatarsalgia

#### Características:

- Zapato gran confort con sistema de cierre ajustable para una perfecta adaptación al tamaño del pie.
- Antepié ancho y flexible.
- Plantilla extraíble que permite el uso de una plantilla ortopédica.
- Efecto doble material para un zapato elegante y femenino.
- Repelente al agua.
- Tejido exterior ligeramente elástico para mejor adaptación a las deformidades de los dedos.

Color: negro



ORLIMAN  
OF1300  
BRÉHAT

PAO  
BAS

TALLA	CN
36	098865
37	098866
38	098867
39	098868
40	098869
41	098870
42	098872

Repuestos disponibles:



Banda  
tobillo  
1 ud

ATX12  
Soporte  
zapato 2 uds

ATX14  
Ganchos  
2 uds

### CONFORTINAS

TALLA	AZUL	BEIGE	NEGRO	BLANCO
34	-----	-----	066971	-----
35	067102	067044	066992	-----
36	067121	067045	066999	066840
37	067129	067049	067012	066847
38	067183	067050	067022	066879
39	067203	067072	067029	071603
40	067218	067078	067030	071615
41	067342	067101	067042	071616
42	066942	066881	066986	-----

## 9.3 GRAN CAPACIDAD



ORLIMAN  
OF010  
OLERÓN  
SUMMER

PAO  
BAS

TALLA	CN
35	098881
36	098882
37	098883
38	098884
39	098885
40	098887
41	098888
42	098890

Ideal para mujeres con dificultad para agacharse

#### Indicaciones:

- Pies muy anchos.
- Empeines pronunciados.
- Dedos en garra, dedos en martillo.
- Durezas, callos.
- Hallux valgus - Juanetes.
- Enfermedades de la uña.
- Edemas postoperatorios.
- Vendajes gruesos.
- Pie reumático y/o artrítico.
- Metatarsalgia.



ORLIMAN  
OF1500  
NOIRMOUTIER

PAO  
BAS

TALLA	CN
36	098891
37	098892
38	098893
39	089316
40	098894
41	098895
42	098896
43	098898
44	098899
45	098900
46	098901

Apertura completa. Modelo alto.  
Plantilla extraíble. Sin costuras

#### Indicaciones:

- Pies muy anchos.
- Empeines pronunciados.
- Dedos en garra, dedos en martillo.
- Durezas, callos.
- Hallux valgus - Juanetes.
- Enfermedades de la uña.
- Edemas postoperatorios.
- Vendajes gruesos.
- Pie reumático y/o artrítico.
- Metatarsalgia.



ORLIMAN  
OF1210  
MOLÉNE

PAO  
BAS

TALLA	CN
35	098873
36	098874
37	098875
38	098876
39	098877
40	098878
41	098879
42	098880

Con plantilla extraíble para el uso de plantillas  
ortopédicas. Ideal para pies operados

#### Indicaciones:

- Pies muy anchos.
- Empeines pronunciados.
- Dedos en garra, dedos en martillo.
- Hallux valgus - Juanetes.
- Pie reumático y/o artrítico.
- Metatarsalgia.
- Postoperatorios.
- Color: azul marino.

10.1 CON AGUJEROS

La elección de zapato con agujeros o no dependerá del tipo de trabajo del usuario. Si el tipo de trabajo conlleva riesgo de derrame de fluidos no deseados encima del pie, se recomienda zueco cerrado.



CLEMENT SALUS NEW LIGHT 0446BL

TALLA	CN
37	098473
38	098474
39	098476
40	098477
41	098478



CLEMENT SALUS NEW LIGHT 0445AZ

TALLA	CN
37	0098466
38	0098469
39	0098470
40	0098471
41	0098472



CLEMENT SALUS NEW LIGHT 444MA

TALLA	CN
37	098461
38	098462
39	098463
40	098464
41	098465

10.2 TOTALMENTE CERRADOS



CLEMENT SALUS ZERO 471 NEGRO

TALLA	CN
37	098486
38	098487
39	098488
40	098489
41	098490
42	098491



CLEMENT SALUS ZERO 470 BLANCO

TALLA	CN
36	098479
37	098480
38	098481
39	098482
40	098484
41	098485

10.3 ZUECO MEDICAL

Los zuecos que acostumbramos a ver en los hospitales.



CINFA ZUECO CONFORT

El de toda la vida

TALLA	BLANCO	AZUL
35	213199	213090
36	213207	213108
37	213215	213116
38	213223	213124
39	213231	213132

TALLA	BLANCO	AZUL
40	213249	213140
41	213256	213157
42	213264	213165
43	020073	020059
44	020080	020066



CINFA ZUECO MICROMASAJE

Con suela de micromasaje Ideal descanso

TALLA	BLANCO	AZUL
35	324830	324863
36	213082	213173
37	213181	342717
38	213272	342808
39	214734	342816

TALLA	BLANCO	AZUL
40	232405	342907
41	324848	324871
42	324855	324889
43	020110	020097
44	020127	020103

10.4 ESTAMPADOS ORIGINALES



CLEMENT SALUS ZERO 532

Estampado dálmata

TALLA	CN
37	098504
38	098505
39	098506
40	098507
41	098508



CLEMENT SALUS ZERO 481BL

Estampado calaveras

TALLA	CN
37	098493
38	098494
39	098495
40	098496
41	098497



CLEMENT SALUS ZERO 531

Estampado medical

TALLA	CN
37	098498
38	098499
39	098500
40	098501
41	098502
42	098503

# 6 ESPECIAL DEPORTE



**Patologías**

1. TRAUMATISMOS FACIALES
2. LUXACIONES HOMBRO LESIÓN MANGUITO ROTADORES
3. CODO DE TENISTA/ GOLFISTA
4. MUÑECA ABIERTA
5. PULGAR DEL ESQUIADOR
6. LUMBALGIAS
7. DESGARRO MUSCULAR
8. RODILLA DEL SALTADOR
8. TENDINITIS ILIOTIBIAL
9. INESTABILIDAD RODILLA
10. SÍNDROME DE LA PEDRADA
10. PERIOSTITIS TIBIAL
11. INESTABILIDAD DE TOBILLO
12. TENDINITIS AQUILEA
13. TIPOS DE PISADA DEL CORREDOR

**Productos relacionados con las patologías**

1. PROTECCIONES DEPORTIVAS .....P.59
  2. HOMBRERAS .....P.59
  3. CODERAS/CINCHAS ..... P.60
  4. MUÑEQUERAS ELÁSTICAS DE COMPRESIÓN .....P.61
  5. MUÑEQUERAS CON PULGAR .....P.61
  6. FAJAS DEPORTE .....P.61
  7. MUSLERAS .....P.62
  8. CINCHA ILIOTIBIAL/ RODILLERA EFECTO CINCHA..... P.62
  9. RODILLERAS .....P.63
  10. CALCETINES Y PERNERAS ..... P.64
  11. TOBILLERAS..... P.64
  12. VER LA SECCIÓN PIE-TALONERAS .....P.47
  13. PLANTILLAS DEPORTE ....P.65
- RECUPERACIÓN MUSCULAR Y VASELINAS .....P.65
  - VENDAJES COMPRESIVOS .....P.65

## 1 PROTECCIONES DEPORTIVAS



**EMO  
MSK100**  
Máscara de  
protección  
facial

TALLA	CN
U	098615



**PRIM  
BRUXICALM**  
SPORT  
Férula  
Bucal

TALLA	CN
U	087291



**MC  
DAVID  
GEL MAX**  
Protector  
bucal

COLORES	CN
Blanco	099420
Negro	099425
Rosa	099422
Transparente	099418



**MC  
DAVID  
602**  
Protector  
de rodilla  
acolchado

TALLA	CONTORNO	CN
S	30-35 cm	099428
M	35-38 cm	099429
L	38-43 cm	099430
XL	43-50 cm	099431

## 2 HOMBRERAS



**MC  
DAVID  
463**

ENVASE	MEDIDAS	CN
S	79-91 cm	085930
M	91-107 cm	085931
L	107-127 cm	085932

Contención  
ante luxaciones  
de hombro



**PRIM  
NEOPRAIR  
NP174**

TALLA	24-26cm	IZQ	DCHA
S	24-26 cm	089056	089055
M	26-28 cm	089057	080930
L	29-32 cm	089059	089058

### 3 CODERAS/CINCHAS

La epicondilitis suele denominarse codo de tenista, al ser estos deportistas quiénes la sufren con más frecuencia.



**TEYDER 210CD**

Con cincha ajustable



TALLA	PERÍMETRO	CN
S	22-24 cm	098409
M	25-27 cm	098408
L	28-30 cm	098407
XL	31-33 cm	098410



**PRIM AQTIVO SPORT P707**

Con cincha ajustable

TALLA	PERÍMETRO	CN
S	23-27 cm	188395
M	27-31 cm	188396
L	31-35 cm	188397



**ACTIMOVE Cincha ajustable**

¡Con placa de frío extraíble!



TALLA	CN
U	098242



**3M FUTURO 45980**

Con cierre de boa



TALLA	CN
U	170989



**CINFA FARMALASTIC NEOPRENO**

Banda epicondilitis

Neopreno



TALLA	CN
U	159070



**ORLIMAN ACE402 EPI'R**



TALLA	CN
U	191496

### 4 MUÑEQUERAS ELÁSTICAS DE COMPRESIÓN

Aportan compresión en casos de inestabilidad, muñeca abierta, o simplemente, para prevenir lesiones.



**PRIM P703 AQTIVO SPORT**

Ajustable

TALLA	CN
U	188372



**PRIM P704 AQTIVO SPORT**

Metacarpiana

TALLA	MEDIDAS	CN
S	14-17 cm	188374
M	17-20 cm	188376
L	20-24 cm	188377



**TEYDER 301MN**

Ajustable



TALLA	PERÍMETRO	CN
S	15-17 cm	202106
M	17-19 cm	202107
L	19-22 cm	202108



**TEYDER 302MN**

Metacarpiana



TALLA	PERÍMETRO	AZUL	NARANJA
S	15-17 cm	202110	202114
M	17-19 cm	212111	202115
L	19-22 cm	202112	202116



**3M FUTURO**

Ajustable



MEDIDAS	CN
14-24,1 cm	218925

### 5 MUÑEQUERAS CON PULGAR



**ORLIMAN ACN503 NEO RHIZO CONFORT**



TALLA	CN
U	191697



**ACTIMOVE THUMB ESTABILIZER**



TALLA	PERÍMETRO	CN
S/M	14-19 cm	199172
L/XL	19-23 cm	199175



**3M FUTURO ESTABILIZADOR DELUXE**

TALLA	PERÍMETRO	CN
S/M	12,7-16,5 cm	170847
L/XL	16,5-20,3 cm	170848



**ORLIMAN OA5000**



TALLA	PERÍMETRO	CN
U	16-21 cm	193428



### 6 FAJAS DEPORTE

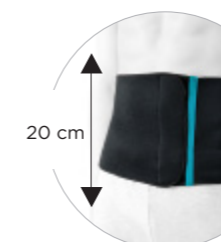

**ORLIMAN ACN601**

Cinturón de neopreno



TALLA	CN
U	191698



**CINFA FARMALASTIC NEOPRENO**

Cinturón



TALLA	CN
U	216150



**CINFA FARMALASTIC NEOPRENO**

TALLA	CONTORNO	CN
1	68-82 cm	319236
2	86-96 cm	319244
3	97-110 cm	319343

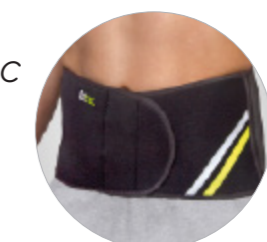

**EMO FJ531**

Con flejes posteriores y doble tensor

TALLA	CINTURA	CN
S	60-75 cm	098617
M	75-90 cm	098618
L	90-105 cm	098619
XL	105-120 cm	098620



**PRIM NEOPRAIR NP156**



TALLA	CINTURA	CN
S	80-90 cm	089050
M	90-100 cm	089051
L	100-112 cm	089053
XL	112-125 cm	089054

## 7 MUSLERAS



### Patología



#### DESGARRO MUSCULAR:

Rotura fibrilar (también llamado tirón o distensión muscular) es la lesión del tejido, que va acompañada de hemorragia provocada por la rotura de los vasos sanguíneos que recorren el músculo o tendón afectado, provocando un dolor de leve a intenso que dificulta o impide contraerlo. Según la cantidad de fibras rotas hablaremos de grado I, II o III.

#### RECOMENDACIONES:

Aplicar frío al momento para contraer los vasos y desinflamar



Rehabilitación, calor y compresión para su recuperación



TEYDER 306ML



TALLA	CONTORNO	CN
S	46-50 cm	202132
M	51-55 cm	202133
L	56-60 cm	202134
XL	61-65 cm	202136



ACTIMOVE POWERMOTION

Muy alta contención. Muslera con cintas de ajuste de presión



TALLA	CONTORNO	CN
S	41-45 cm	098234
M	45-50 cm	098235
L	50-56 cm	098237
XL	56-63 cm	098238
XXL	63-70 cm	098240

## 8 CINCHA ILIOTIBIAL / RODILLERA EFECTO CINCHA

Se abren completamente. Muy fácil colocación



MC DAVID 419

TALLA	CONTORNO	CN
S/M	30-38 cm	085870
L/XL	38-51 cm	047006



MC DAVID 4201 VOW

TALLA	CONTORNO	CN
S	32,4-36,2 cm	085871
M	34,9-38,7 cm	085872
L	38,1-42,5 cm	085873
XL	41,9-47 cm	085874



MC DAVID 414 Cincha infrapatelar

TALLA	CN
U	052482



MC DAVID 4103 Cincha iliotibial

TALLA	CN
U	085869

## 9 RODILLERAS

### 9.1 RODILLERAS DE COMPRESIÓN



CINFA FARMALASTIC SPORT

Estabilizador de rodilla

TALLA	CONTORNO	CN
XS	32-35 cm	177123
S	35-38 cm	177124
M	38-41 cm	177125
L	41-44 cm	177126
XL	44-47 cm	177127



CINFA FARMALASTIC SPORT

Estabilizador de rodilla reforzado

Hecho para el esquí ¡Ultraligero!

TALLA	CONTORNO	CN
XS	32-35 cm	185782
S	35-38 cm	185783
M	38-41 cm	185784
L	41-44 cm	185786
XL	44-47 cm	185787



TEYDER 220RD



TALLA	CONTORNO	CN
S	33-36 cm	099437
M	36-38 cm	099436
L	39-42 cm	099435
XL	42-46 cm	099438



TEYDER 304RD



TALLA	CONTORNO	CN
S	30-34 cm	202123
M	34-38 cm	202124
L	38-42 cm	202125
XL	42-46 cm	202126



PRIM AQTIVO SPORT P700

TALLA	CONTORNO	CN
S	32-35 cm	188358
M	36-39 cm	188360
L	40-46 cm	188361
XL	47-52 cm	190438

### 9.2 RODILLERAS CON FLEJES

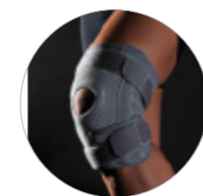

CINFA FARMALASTIC

Rotuliana con cinchas



TALLA	CN
Abierta	159084
Cerrada	159083



3M REFORZADA AJUSTABLE 48579



TALLA	RANGO	CN
U	40,6-48,3	163452



TEYDER 235RD

Elástica con rodete rotuliano



TALLA	PERÍMETRO	CN
S	33-36 cm	098413
M	36-38 cm	098412
L	39-42 cm	098411
XL	42-46 cm	098414



TEYDER 236RD

Elástica con articulación policéntrica



TALLA	PERÍMETRO	CN
S	33-36 cm	098405
M	36-38 cm	098404
L	39-42 cm	098403
XL	42-46 cm	098406



## 10 CALCETINES Y PERNERAS



**TEYDER 308TB**  
Calzón de compresión



TALLA	CONTORNO	NARANJA	AZUL
S	17-20 cm	202146	202141
M	20-23 cm	202147	202142
L	23-27 cm	202148	202144
XL	27-32 cm	202149	202145

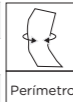

**TEYDER 307PR**  
Perna



TALLA	CONTORNO	AZUL
S	32-36 cm	202137
M	36-40 cm	202138
L	40-44 cm	202139
XL	44-48 cm	202140



**ACTIMOVE POWERMOTION**

Muy alta contención gracias a sus cintas de ajuste de presión



TALLA	CONTORNO	CN
S	29-34 cm	098231
M	34-40 cm	098232
L	40-47 cm	098233

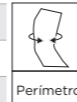

## 11 TOBILLERAS



**ACTIMOVE TOBILLERA AJUSTABLE**



TALLA	CONTORNO	CN
S	18-20,5 cm	199192
M	20,5-23 cm	199193
L	23-25,5 cm	199194



**CINFA FARMALASTIC SPORT**

Ideal para la práctica de deportes de impacto repetitivo

TALLA	CONTORNO	CN
S	18,5-20 cm	187570
M	20-21,7 cm	187571
L	21,7-23,4 cm	187572
XL	23,4-25 cm	187573



**TEYDER 305TB**



TALLA	CONTORNO	NARANJA	AZUL
S	15-19 cm	202159	202128
M	19-23 cm	202160	202129
L	23-28 cm	202161	202130
XL	28-33 cm	202162	202131



**PRIM AQTIVO SPORT P706**

Con cincha ajustable

TALLA	CONTORNO	CN
S	17-20 cm	188388
M	20-23 cm	188389
L	23-26 cm	188390



**MC DAVID 195**

Tobillos estabilizadora

Con estabilizadores laterales y cierre con cordones



TALLA	Nº DE PIE	CN
XS	38,5	085827
S	40-42,5	085828
M	42,5-44,5	085830
L	44,5-47,5	085831
XL	+48	085832



! Encontrarás más modelos en el capítulo de extremidad inferior.

## 13 PLANTILLAS DEPORTE



Según el tipo de pisada del corredor:



**FLEXOR Plantillas running**

Para pie pronador

Nº de pie	CN
40	099349
41	099348
42	099458
43	099463



**FLEXOR Plantillas running**

Para pie supinador

Nº de pie	CN
40	099485
41	099350
42	099484
43	099483



**FLEXOR Plantillas running**

Para pie neutro

Nº de pie	CN
40	099460
41	099459
42	099335
43	099339



**ORLIMAN SPORT OS6706**

Plantilla deportiva con descarga en talón y metatarsos

TALLA	Nº CALZADO	CN
1	36-37	190680
2	38-39	190681
3	40-41	190682
4	42-43	190683
5	44-45	190684

## 14 RECUPERACIÓN MUSCULAR Y VASELINAS



**MADFORM CREMY GEL**

Crema de calentamiento  
Previo a la práctica deportiva

ML	CN
60	176372
120	176371



**MADFORM MAD FREEZE**

Alivio para las zonas musculares  
Frio

ML	CN
60	176367
120	176364



**MADFORM DOBLE POTENCIA**

Recuperación muscular intensiva

ML	CN
60	176369
120	176368



**MADFORM SPORT FÓRMULA**

Recuperación muscular  
Acción frío/calor

ML	CN
60	176366
120	176365



**BASE 25**

Vaselina deportiva

VOLUMEN	CN
100 ml	185498
250 ml	185499

## 15 VENDAJES COMPRESIVOS



**MADFORM Vaselina deportiva**

MONODOSIS	CN
24 unidades	051896



**PRIM P720AZ**

Vendaje tubular compresivo sport

TALLA	CONTORNO	ANCHO	CODO	MUÑECA	MUSLO	RODILLA	TOBILLO	CN
A	13-16 cm	6,3 cm		X				194762
B	16-20 cm	6,8 cm	X	X			X	194763
C	20-24 cm	7,5 cm	X	X		X	X	194764
D	24-28 cm	8,8 cm	X		X	X	X	194765
E	28-36 cm	10 cm			X	X		194766
F	36-46 cm	12 cm			X			194767



**Patologías**

- CERVICALGIA
- TORTÍCOLIS
- ARTROSIS CERVICAL

- ARTROSIS
- OSTEOPOROSIS
- LUMBALGIA
- CIÁTICA
- CONTRACTURA

- FASCITIS PLANTAR

- LESIÓN EN MANGUITO DE ROTADORES

- EPICONDILITIS/ EPITROCLEITIS

- INESTABILIDAD DE RODILLA

- DESGARRO MUSCULAR / ROTURA FIBRILAR

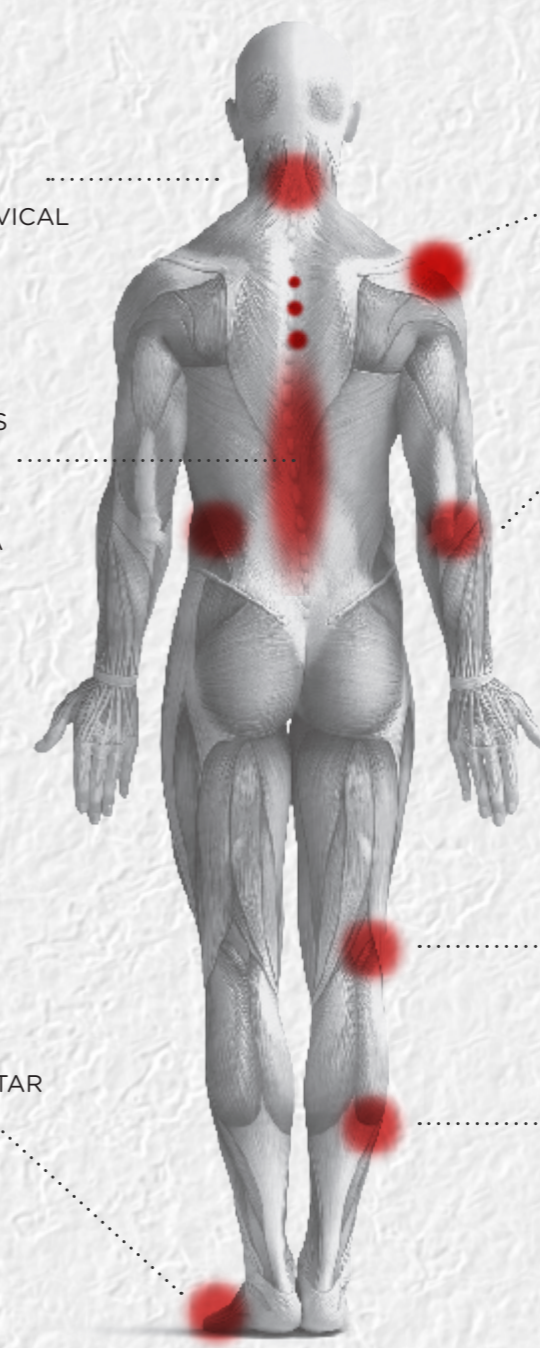

**Productos relacionados con las patologías**

1. TERMOTERAPIA..... P.69
2. CRIOTERAPIA..... P.70
3. ELECTROESTIMULACIÓN ..... P.71
4. MAGNETOTERAPIA ..... P.72
5. EJERCITADORES ..... P.73
6. TAPES / PRE-TAPES Y VENDAS COMPRESIVAS ..... P.73

# 1 TERMOTERAPIA



## THERMACARE

TALLA	CONTORNO	CN
CUELLO	2uds	159364
CUELLO	6uds	167427
ADAPTABLE	3uds	171342
ZONA LUMBAR	2uds	159363
ZONA LUMBAR	4uds	167426



**CRIOTERM**  
Parches Lumbar y cadera

ENVASE	CN
2 uds	195901



**CRIOTERM**  
Parches Cuello y hombro

ENVASE	CN
4 uds	195900



**ACOFAR**  
Parches térmicos

ENVASE	CN
PAR	195128



**GARCIA 3028**  
Almohadilla eléctrica

MEDIDAS	CN
40x32 cm	097945



**NEOCARE**  
Almohadilla térmica

MEDIDAS	CN
40x30 cm	099300



**NEOCARE**  
Almohadilla térmica XL

MEDIDAS	CN
60x30 cm	099301

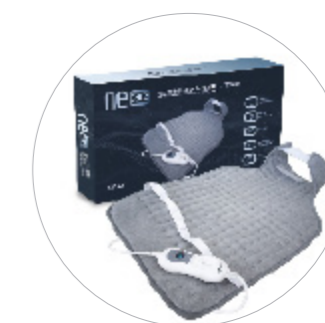

**NEOCARE**  
Almohadilla térmica Cervical-dorsal

MEDIDAS	CN
63x42 cm	099302



CN
099359



CN
099445



CN
099358



CN
099357



CN
040407



CN
099319



CN
099320

## 2 CRIOTERAPIA



DJO  
DURASOFT  
RODILLA

TALLA	CN
U	099128



DJO  
DURASOFT  
TOBILLO

TALLA	CN
U	099129

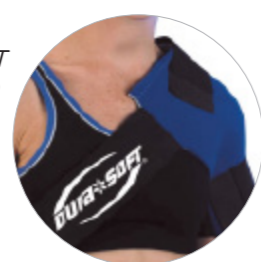

DJO  
DURASOFT  
HOMBRO

TALLA	CN
U	099130



CALVO  
IZQUIERDO  
41024

Bolsa de frío instantáneo  
**¡Sin caja!**

ENVASE	CN
UNIDAD	098324



CALVO  
IZQUIERDO  
41045

Bolsa de frío reutilizable  
**Con caja**

ENVASE	CN
UNIDAD	098325



CALVO  
IZQUIERDO  
41042

ENVASE	CN
400 ml	185848



DJO  
SPRAY

ENVASE	CN
200 ml	098999



BIOFREEZE

ENVASE	CN
32 g	087003
120 g	156481
480 g	038432
960 g	032315
roll-on	156479



CRIOTERM  
Bolsa frío-calor

ENVASE	CN
UNIDAD	192029



NEXCARE  
Bolsa de frío-calor

ENVASE	MEDIDAS	CN
2 uds	15x18 cm	203124



NEXCARE  
Bolsa de frío-calor

ENVASE	MEDIDAS	CN
1 ud	10x26,5 cm	211599



NEXCARE  
Bolsa de frío-calor

ENVASE	MEDIDAS	CN
1 ud	11x26 cm	190354

**¡Con indicador de temperatura!**



NEXCARE  
Bolsa de frío-calor

ENVASE	MEDIDAS	CN
1 ud	19,5x30 cm	231878

**!Maxi!**



NEXCARE  
Bolsa de frío-calor

ENVASE	MEDIDAS	CN
1 ud	11x12 cm	231845

## 3 ELECTROESTIMULACIÓN



APEX  
DIGI STIM

**Dolor**

PESO	APARATO	CN
140 g	10,8x6,15x2,5 cm	099000

### Tens portátil

Aparato para el alivio de dolor muscular mediante una terapia analgésica que usa la técnica de la estimulación electrónica transcutánea del nervio periférico. Ofrece 5 modos de estimulación:

- 1 Ráfaga (B)
- 2 Continuo (C)
- 3 Modulación (M)
- 4 Intensidad, duración y modulación de frecuencia (SDR)
- 5 Intensidad, duración y modulación de anchura



APEX  
DIGI COMBO

**Dolor + estimulación muscular**

PESO	APARATO	CN
140 g	10,8x6,15x2,5 cm	099001

### Tens + EMS

**(electronic muscle stimulation) portátil**  
Alivio del dolor + estimulación muscular. Además de los 5 modos *tens* anteriores, dispone de 3 modos EMS:

- 1 Sincrónico (S)
- 2 Constante (C)
- 3 Alternancia (A)



APEX

Recambio electrodos cuadrados

CANTIDAD	CN
4 unidades	099003

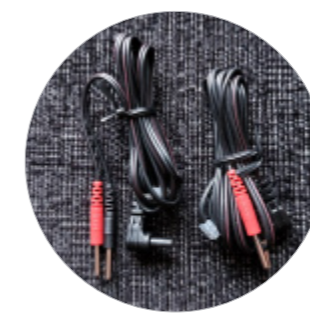

APEX

Cables electrodos

CANTIDAD	CN
2 unidades	099004

## 4 MAGNETOTERAPIA



MAG 2000

¿Necesitas alquilar o comprar la máquina? Escríbenos a [ortopedia@fedefarma.com](mailto:ortopedia@fedefarma.com)

La magnetoterapia es un tratamiento terapéutico ahora reconocido y consolidado en el campo de la rehabilitación, apoyado por una sólida bibliografía médica.

Los campos electromagnéticos pulsados bioestimulan las células del cuerpo humano, restableciendo el correcto potencial eléctrico intra / extra celular, perdido como resultado de un trauma o una enfermedad.

La ausencia casi total de contraindicaciones hace que la magnetoterapia sea especialmente adecuada para tratamiento de enfermedades que afectan el sistema musculoesquelético.

### BIOESTIMULACIÓN

Hablamos de bioestimulación electromagnética de las células del cuerpo humano. La variación del campo magnético bioestimula las células restaurando el potencial eléctrico correcto intra / extra celular.

### OBJETIVO

El objetivo de la magnetoterapia es restaurar el equilibrio fisiológico de la célula que se pierde durante los estados inflamatorios (enfermedades, traumas, infecciones, etc.).

### PATOLOGÍAS PRINCIPALES

Osteoporosis, fracturas, lesiones cartilaginosas, cervicalgia, esguinces, contracturas musculares, dolores lumbares, osteonecrosis, artrosis / artritis, retrasos en la calcificación, algodistrofia, epicondilitis / epitrocleititis, dolor muscular, reumatismo.

### MAGNETOTERAPIA DE BAJA FRECUENCIA

Campos electromagnéticos con intensidad media-alta, pero a bajas frecuencias (máximo 150 Hz) que resultan particularmente indicados para el tratamiento de enfermedades que afectan a tejidos duros y estados inflamatorios. Se mide en Gauss.

### MAGNETOTERAPIA DE ALTA FRECUENCIA

Se basa en la emisión de pequeños "paquetes" de ondas de radio de alta frecuencia (entre 18 y 900 MHz) pero baja intensidad (unos pocos milivatios) que son particularmente adecuados para el tratamiento de enfermedades que afectan los tejidos blandos.

### INDICACIONES DE TRATAMIENTO

Realice ciclos diarios de una duración mínima de 2-4 horas. Duración promedio de un ciclo efectivo: 45-60 días. Si es necesario, repita el tratamiento varias veces durante el año (por ejemplo, en el caso de la artritis, la osteoporosis, o el dolor en las articulaciones).

## 5 EJERCITADORES



GARCÍA  
Bandas elásticas de rehabilitación

MEDIDAS	COLOR	DUREZA	CN
1200x150 mm	ROSA	BLANDA	097946
	ROJA	MEDIA	097947
	AZUL	FUERTE	097948



PRIM 13108  
Baño de parafina

ENVASE	CN
UNIDAD	052883



CALVO IZQUIERDO  
Bloque de parafina

BLOQUE	CN
2,K kg	098332



GARCÍA 2139  
Pedalier plegable

ENVASE	CN
UNIDAD	097954

## 6 TAPES/PRE-TAPES Y VENDAS COMPRESIVAS

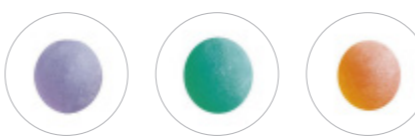

Bolas de rehabilitación

GARCÍA 2451 GARCÍA 2452 GARCÍA 2453

COLOR	DUREZA	CN
AZUL	BLANDA	097950
VERDE	MEDIA	097951
NARANJA	FUERTE	097953

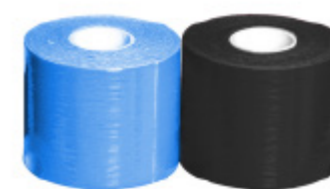

CALVO IZQUIERDO  
Tape

COLOR	MEDIDAS	CN
Negro	2,5x5 cm	098330
Negro	5x5 cm	098328
Azul	5x5 cm	098329



CALVO IZQUIERDO  
Pre-tape

MEDIDAS	CN
7x27 cm	098331



PRIM P720BG  
Vendaje tubular compresivo skin

TALLA	CONTORNO	ANCHO	CODO	MUÑECA	MUSLO	RODILLA	TOBILLO	CN
B	13-16 cm	6,3 cm		X				194755
C	16-20 cm	6,8 cm	X	X			X	194756
D	20-24 cm	7,5 cm	X	X		X	X	194757
E	24-28 cm	8,8 cm	X		X	X	X	194758
F	28-36 cm	10 cm			X	X		194759
G	36-46 cm	12 cm			X			194760

**Patologías**

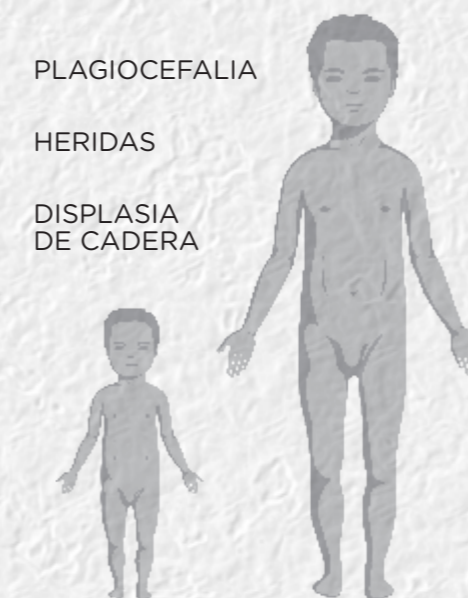

**PATOLOGÍAS TÍPICAS DEL CRECIMIENTO**

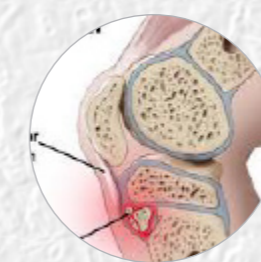

• OSGOOD SCHLATTER



• PATOLOGÍA DE SEVER

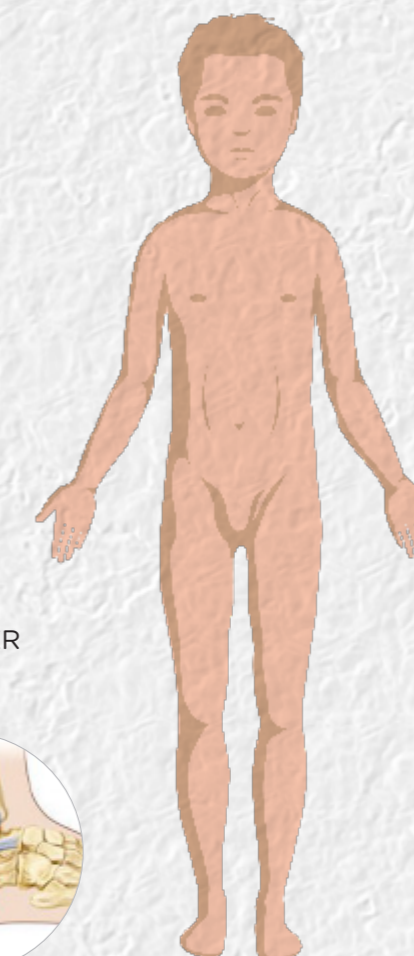

**Productos relacionados con las patologías**

1. **PEDIATRÍA: BEBÉS**
  - 1.1 COJINES..... P.77
  - 1.2 VENDAJES CORDÓN UMBILICAL..... P.77
2. **NIÑ@S: HASTA 12 AÑOS**
  - 2.1 CASCOS PROTECTORES ..... P.78
  - 2.2 BANDAS ÓTICAS/TAPONES Y CORRECTORES..... P.78
  - 2.3 PARCHES OCULARES..... P.78
  - 2.4 PROTECTORES BUCALES..... P.78
  - 2.5 INMOVILIZADORES CLAVICULARES..... P.79
  - 2.6 COLLARINES..... P.79
  - 2.7 CABESTRILLOS..... P.79
  - 2.8 CODERAS..... P.79
  - 2.9 MUÑEQUERAS ..... P.79
  - 2.10 RODILLERAS..... P.80
  - 2.11 TOBILLERAS ..... P.80
  - 2.12 WALKERS..... P.80
3. **MOVILIDAD**
  - 3.1 MULETAS..... P.81
  - 3.2 SILLAS DE RUEDAS ..... P.81
  - 3.3 SUJECIONES ..... P.81

# 1 PEDIATRÍA: BEBÉS

## 1.1 COJINES Y ALMOHADAS



**QBIO  
UBIOBABY**  
Cojín postural infantil

EDAD	MEDIDAS	CN
0-3 M	26x21x3 cm	099307
3-10 M	26x21x4 cm	099308
10-20 M	30x24x4 cm	099318

**PLAGIOCEFALIA:**

Aplanamiento de la parte trasera de la cabeza y/o desplazamiento del mismo lado de la cabeza hacia delante.

**BRAQUICEFALIA:**

Aplanamiento más o menos simétrico de toda la parte trasera de la cabeza.

**ESCAFOCEFALIA:**

Cabeza estrecha y alta por aplanamiento transversal y alargada en sentido antero-posterior.

**TORTÍCOLIS MUSCULAR CONGÉNITA:**

Se manifiesta durante los dos primeros meses de vida y se asocia a un acortamiento del músculo esternocleidomastoideo.

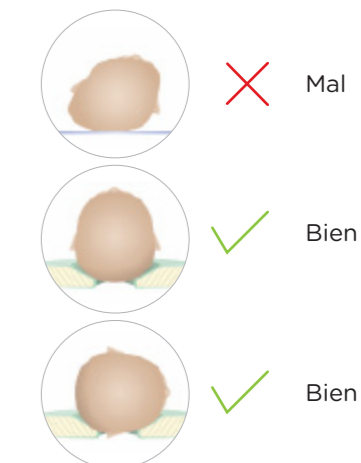

**QBIO  
604260**  
Almohada antireflujo

EDAD	MEDIDAS	CN
≥ 0 meses	42x31,5x5 cm	098685



**PRIM  
VIADOL  
FIX BABY**  
Banda umbilical

Malla tubular elástica para la sujeción del apósito que protege el cordón umbilical

ENVASE	CN
UNIDAD	328567

2.1 CASCOS PROTECTORES



**QBIO 702020**  
Casco de neopreno adaptable

ENVASE	CONTORNO	CN
UNIDAD	55-59 cm	098662

2.2 BANDAS ÓTICAS/TAPONES Y CORRECTORES



**PRIM**  
Banda protectora de oídos

ENVASE	CN
1 ud	033652



**PRIM**  
Silicona infantil

ENVASE	CN
6 uds	254755



**PRIM OTOSTICK**  
Corrector de oídos

ENVASE	CN
8 uds	169554

2.3 PARCHES OCULARES



**ORTOPAD SOFT BOYS**

EDAD	MEDIDAS	CN
0-2 AÑOS	67x50 mm	191994
2-4 AÑOS	76x54 mm	191995
+4 AÑOS	85x59 mm	191996



**ORTOPAD SOFT GIRLS**

EDAD	MEDIDAS	CN
0-2 AÑOS	67x50 mm	191997
2-4 AÑOS	76x54 mm	191998
+4 AÑOS	85x59 mm	192000

2.4 PROTECTORES BUCALES



**MC DAVID**

COLOR	CN
BLANCO	099421
NEGRO	099426
ROSA	099423
TRANSPARENTE	099419

2.5 INMOVILIZADORES CLAVICULARES



**ORLIMAN OP1130**

TALLA	EDAD	PERÍMETRO	CN
1	2 a 6	48-58 cm	078024
2	6 a 12	58-72 cm	078025

2.7 CABESTRILLOS



**ORLIMAN OP1133**

TALLA	CN
U	084414



**ORLIMAN OP1132**  
Con cincha inmovilizadora

TALLA	LONGITUD	CN
1	<23 cm	078062
2	30 cm	078064



**TEYDER 430 CK**  
Con cincha inmovilizadora

TALLA	LONGITUD	CN
XXS	22 cm	098430
XS	27 cm	098429



**TEYDER 282CK**

TALLA	PERÍMETRO	CN
XXS	16-18 cm	098432
XS	18-20 cm	098431

2.3 PARCHES OCULARES

2.9 MUÑEQUERAS



**TEYDER 285MK**

TALLA	PERÍMETRO	CN
XXS	11-12 cm	098438
XS	12-13 cm	098439



**ORLIMAN OP1154**  
Circular

TALLA	CN
U	078136



**TEYDER 486RK**  
Con férula

TALLA	PERÍMETRO	CN
XXS	22 cm	098437
XS	27 cm	098436



**TEYDER 486AC**  
Accesorio inmovilizador de pulgar

TALLA	CN
XXS	098435
XS	098433





Patología



**OSGOOD SLATER:**  
Los huesos crecen más rápido que los músculos y tendones, y estos ejercen tracción en el punto de inserción al hueso.

RECOMENDACIONES:



CINCHA INFRAPATELAR (la encontrarás en el capítulo de la extremidad inferior)



Patología



**TALALGIA DE SEVER:**  
Dolor localizado en la inserción del tendón de Aquiles o en el talón.

RECOMENDACIONES:



TALONERAS (las encontrarás en el capítulo de pie)

¿Sabías que hay 2 patologías muy típicas en edad de crecimiento?

2.10 RODILLERAS



TEYDER 283RK

Elástica

TALLA	PERÍMETRO	CN
XXS	22-26 cm	098441
XS	26-30 cm	098440



ORLIMAN OP1180

Inmovilizadora

TALLA	PERÍMETRO	ALTO	CN
1	24-30 cm	24 cm	084456
2	30-36 cm	34 cm	084457

2.11 TOBILLERAS



ORLIMAN OP1190

TALLA	PERÍMETRO	CN
1	<20 cm	084465
2	<24 cm	084466

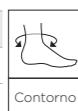

Contorno



TEYDER 284TK

TALLA	PERÍMETRO	CN
XXS	13-16 cm	098444
XS	16-19 cm	098443

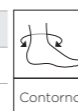

Contorno

2.12 WALKERS



DJO WALKERS PEDIÁTRICOS

TALLA	Nº de pie	COLOR	CN
S	<25	NARANJA	098995
M	25-29	AZUL	098997
L	25-33	AMARILLO	098998

3 MOVILIDAD

3.1 MULETAS

Abrazadera de diámetro estrecho  
Niños hasta 7 años



DISEÑO	REFERENCIA	CANTIDAD	CN
LUNARES	21614		098516
DEPORTE	21613	PAR	097958
FÚTBOL	21619		097959

Abrazadera de diámetro más ancho  
Niños > 7 años



DISEÑO	REFERENCIA	CN	DISEÑO	CN
GRIS	2162	097960	COLORES	078711

3.2 SILLAS DE RUEDAS



VERMEIREN 708 KIDS



Para consultar otras tallas o para más información escribir a: [ortopedia@fedefarma.com](mailto:ortopedia@fedefarma.com)



REFERENCIA	ANCHO	CN
401811	32	098713
4018128	37	098714

VERMEIREN BZ8 KIDS  
Reposapiés infantil



TALLA	IZQ	DCHA
32	098823	098825
37	098824	098826

3.3 SUJECIONES



TEYDER X591AR

Arnés perineal infantil

ANCHO	DISTANCIA	CN
XXS	18-22 cm	098449
XS	22-28 cm	098447



TEYDER X590AR

Arnés torácico infantil

ANCHO	DISTANCIA	CN
XXS	18-22 cm	098446
XS	22-28 cm	098445



Distancia



Situaciones

1. EMBARAZO/ LACTANCIA

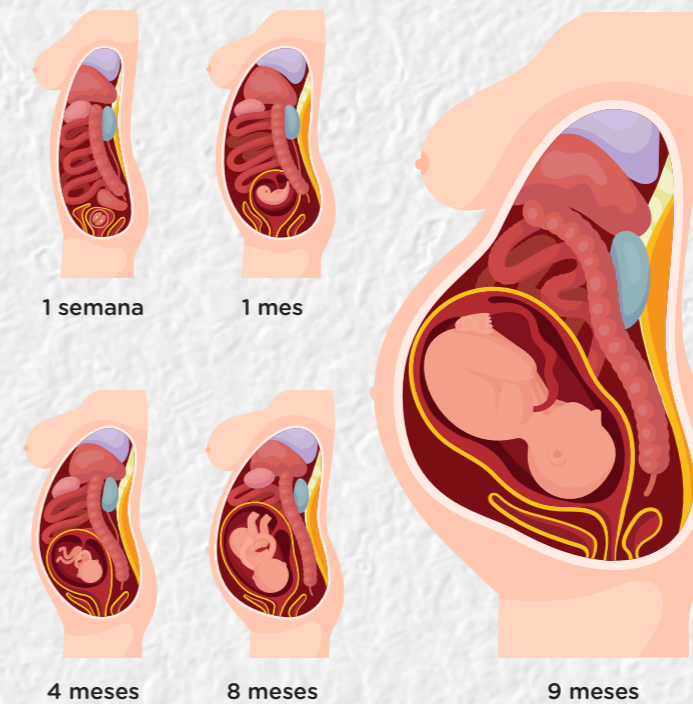

2. REDUCTORES



3. MASTECTOMÍA

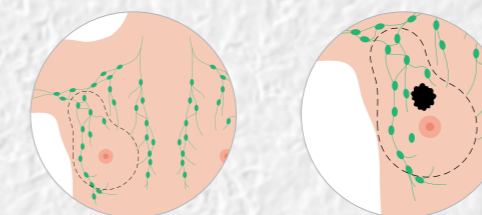

Productos relacionados con las patologías

1. EMBARAZO/LACTANCIA

- 1.1 FAJAS DE EMBARAZO Y POSTPARTO .....P.85
- 1.2 COJÍN DE LACTANCIA.....P.85
- 1.3 MEDIAS .....P.85

2. REDUCTORES

- 2.1 BANDAS ABDOMINALES..... P.86
- 2.2 LEGGINS..... P.86
- 2.3 BODYS POST-LIPOSUCCIÓN .....P.87

3. PRÓTESIS.....P.87

# 1 EMBARAZO-LACTANCIA

## 1.1 FAJAS DE EMBARAZO Y POSTPARTO

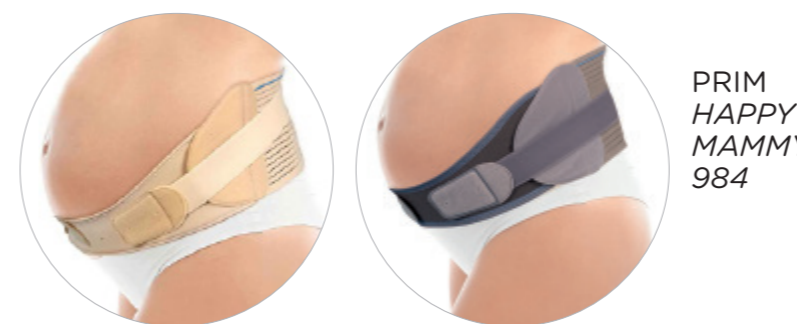

PRIM  
HAPPY  
MAMMY  
984

COLOR	CN
BEIGE	178597
GRIS	178598



CINFA  
FARMALASTIC  
Cinturón  
pélvico con  
refuerzo lumbar

TALLA	CONTORNO	CN
1	90-105 cm	330652
2	105-120 cm	330653
3	120-135 cm	330655



CINFA  
FARMALASTIC  
Faja lumbar

TALLA	CONTORNO	CN
1	75-95 cm	154070
2	95-115 cm	154088
3	115-130 cm	155317
4	130-140 cm	267708

## 1.2 COJÍN DE LACTANCIA



GARCÍA  
3039  
Cojín de  
lactancia

MEDIDAS	CN
100 x 25 cm	097955



SIGVARIS  
PANTY  
Pre-mamá  
transparente  
Composición:  
Poliamida  
Elastán

TALLA	TOBILLO	PANTORRILLA	MUSLO	N (<75cm)	L (>75cm)
S	19-22 cm	30-39 cm	45-60 cm	099596	099597
M	22-24 cm	33-42 cm	49-64 cm	099599	099603
L	24-26 cm	37-46 cm	54-69 cm	099602	099601
XL	26-29 cm	40-49 cm	56-71 cm	099600	099594
				pie 36-40	pie 37-41

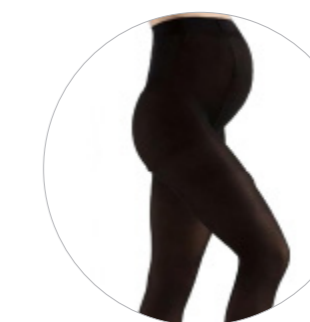

SIGVARIS  
PANTY  
Pre-mamá  
opaco  
Composición:  
Poliamida  
Elastán

TALLA	CONTORNO	PANTORRILLA	MUSLO	N (<75cm)	L (>75cm)
S	19-22 cm	32-38 cm	45-62 cm	099496	099495
M	22-24 cm	35-41 cm	48-65 cm	099494	099493
L	24-26 cm	38-44 cm	51-68 cm	099492	099491
XL	26-29 cm	41-47 cm	54-71 cm	099490	099489
				pie 36-40	pie 37-41

## 1.3 MEDIAS

Sigue la evolución del vientre durante todo el embarazo gracias a su cintura evolutiva y ofrece un soporte ventral adecuado. El diseño particularmente refinado de la cintura aporta un toque de feminidad y elegancia.

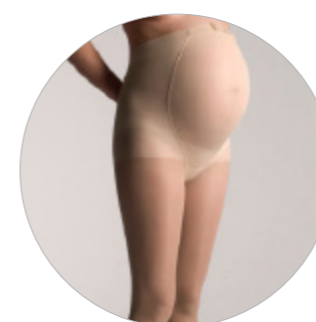

CINFA  
FARMALASTIC

PANTY EMBARAZADA (E-T)				
COLOR	P	M	G	EG
NEGRO	211516	211524	211532	211557
BEIGE	331801	331793	331785	221895



CINFA  
FARMALASTIC

PANTY PREMAMÁ INTELLIGENT PLUS					
COLOR	I	II	III	IV	V
CANELA	173960	173966	173972	173977	173982
CAVIAR	173961	173967	173973	173978	173983

## 2 REDUCTORES

### 2.1 BANDAS ABDOMINALES



**TEYDER 902FV**  
Banda reductora

TALLAS	PERÍMETRO	CN
S/M	85-95 cm	098415
L/XL	96-105 cm	098416



15 CM  
Altura delantera



24 CM  
Altura trasera

*Leggins* y bandas anticelulíticas. Reductores y reafirmantes gracias a su tecnología *fir* y efecto micro-masaje de acción anticelulítica y reductora.

Activa la microcirculación sanguínea, elimina toxinas, grasa localizada, celulitis y piel de naranja.

Hilatura de minerales. Resultados testados y certificados científicamente.

### 2.2 LEGGINS

No usar más de 6-8h/día.



**TEYDER 927PT**  
Body reductor Shapecell

TALLA	CN
S/M (36-44)	098425
L/XL (44-52)	098424



TALLA	GRIS	AZUL	ROJO
S/M (36-44)	098419	098421	098423
L/XL (44-52)	098417	098420	098422



**TEYDER 925PT**  
Pantalón pirata reductor shapecell

## 2.3 BODY POST-LIPOSUCCIÓN



**VOE**  
Soporte abdominal con tirantes  
3007: beige  
3007-2: negro



TALLA	3007	3007-2
XXS	099387	099397
XS	099388	099398
S	099389	099399
M	099391	099400
L	099373	099392
XL	099383	099393
XXL	099384	099394



**VOE**  
Soporte abdominal con corchetes  
4008: beige  
4008-2: negro



TALLA	4008	4008-2
XXS	099407	099415
XS	099405	099413
S	099403	099411
M	099402	099410
L	099401	099409
XL	099404	099412
XXL	099406	099414

#### Prendas liposucción

TALLA	CINTURA (cm)	CADERA (cm)	MUSLO (cm)
70 (XXXXXS)	54-58	80-85	43-46
75 (XXXS)	58-64	85-90	46-49
80 (XXS)	64-68	90-95	49-52
85 (XS)	68-72	95-100	52-55
90 (S)	72-76	100-105	55-58
95 (M)	76-80	105-110	58-61
100 (L)	80-85	110-115	61-64
105 (XL)	85-90	115-120	64-67
110 (XXL)	90-95	120-125	67-69
115 (XXXL)	95-100	125-135	69-71

## 3 PRÓTESIS

¿Qué tipo de prótesis es la más adecuada para mí?



Si tienes dudas, ¡ESCRÍBENOS!  
[ortopedia@fedefarma.com](mailto:ortopedia@fedefarma.com)



# 10 VASCULAR

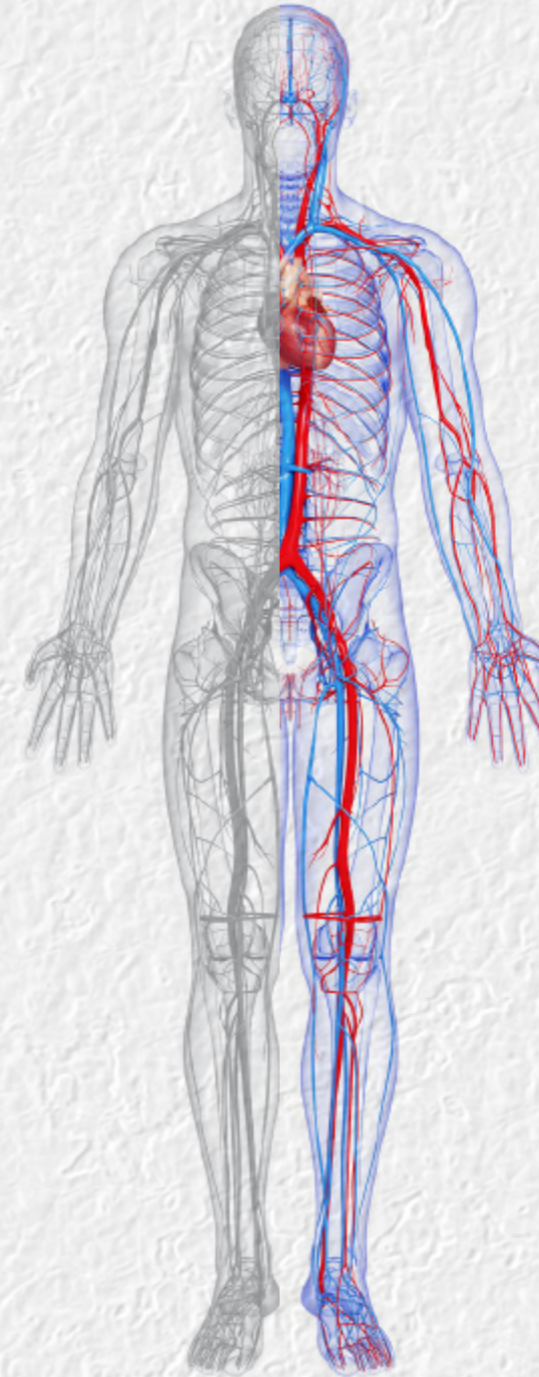

INTRODUCCIÓN .....	P.90
<b>1. PREVENCIÓN</b>	
1.1 COMPRESIÓN LIGERA .....	P.91
1.2 COMPRESIÓN NORMAL .....	P.93
<b>2. TRATAMIENTO</b>	
2.1 COMPRESIÓN FUERTE .....	P.96
<b>3. POSTOPERATORIO .....</b>	P.97
<b>4. PRODUCTOS ESTÁNDAR PARA PATOLOGÍA LINFÁTICA Y EDEMA .....</b>	P.98
<b>5. ACCESORIOS .....</b>	P.98

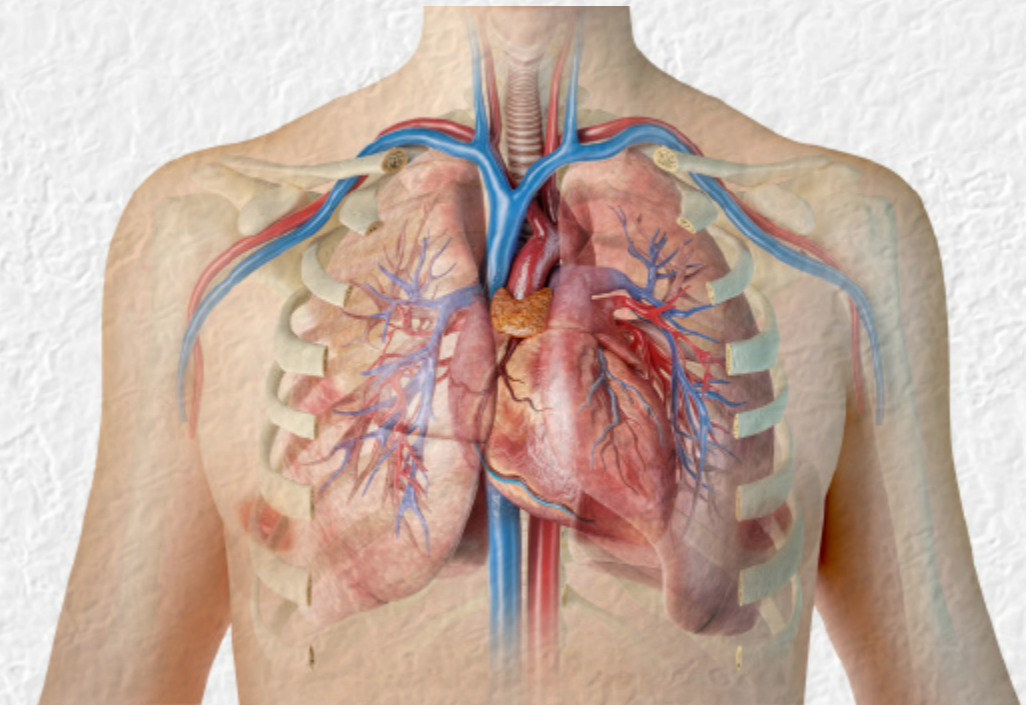



¿QUÉ DEBEMOS TENER EN CUENTA A LA HORA DE RECOMENDAR O DISPENSAR UNA MEDIA?

# 1 EL NIVEL DE COMPRESIÓN ADECUADO PARA CADA NIVEL DE PATOLOGÍA

## Patología

**Patología clasificación CEAP 0, 1** ..... Tipo de compresión  
(Sin signos visibles, telangiectasias o varices reticulares) ..... Compresión Ligera

**Patología clasificación CEAP 2, 3** ..... Compresión Media  
(Variz y edema)

**Patología clasificación CEAP 4, 5, 6** ..... Compresión Fuerte  
(Signos dérmicos, úlcera cicatrizada o activa, postoperatorio)

# 2 EL TIPO DE PRENDA EN FUNCIÓN DE LA LOCALIZACIÓN DE LOS SÍNTOMAS Y EL PERFIL DEL PACIENTE

## Localización

**Debajo de la rodilla** ..... Media A-D: Media Corta y Calcetín

**Encima de la rodilla** ..... Media A-F/A-G: Media Larga Media Entera E-T: Panty

## Tipos de productos

# 3 ELECCIÓN DE LA TALLA CORRECTA EN FUNCIÓN DE LA TOMA DE MEDIDAS

## FARMALASTIC

- ① Largura desde el suelo hasta el punto de medida.
- Ⓒ Contorno.
- Ⓓ Cintura o borde superior de los pantys.
- Ⓚ Interior de la pierna medida verticalmente del suelo a la entepierna.
- Ⓖ Dos dedos por debajo de la entepierna (el borde debe acabar debajo de la curva del glúteo).
- Ⓕ Medio muslo, dos dedos por debajo del glúteo.
- Ⓗ Cabeza de la tibia (dos dedos por debajo de la rótula).
- Ⓒ El punto más ancho de la pantorrilla (gemelo).
- Ⓑ El punto más estrecho de la parte inferior de la pierna (tobillo sobre los maleolos).

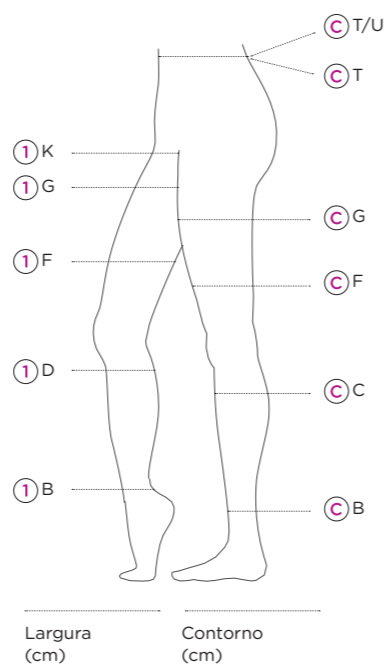

## SIGVARIS

Peso/Altura

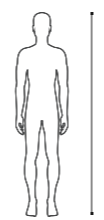

Nº de pie



# 1 PREVENCIÓN

## 1.1 COMPRESIÓN LIGERA

FARMALASTIC, UN BÁSICO 12-21 mmHg



### MEDIA LARGA

COLOR	P	M	G	EG
NEGRO	302000	302018	302026	302034
VISÓN	302042	301382	301390	301408
CAPUCCINO	192630	192631	192632	192634



### PANTY COMPLET 70

COLOR	P	M	G	EG
NEGRO	314203	315366	315101	315119
VISÓN	314575	314583	315176	315168
CAMEL	315135	315127	315184	315143

PARA LOS QUE BUSCAN DISEÑO 15-17 mmHg



### MEDIA CORTA ELEGANT

COLOR	I	II	III
ANTRACITA	173835	173840	173845
CANELA	173832	173837	173842
CAVIAR	173834	173839	173844
CHOCOLATE	173833	173838	173843
MARINO	173836	173841	173846



### MEDIA LARGA ELEGANT

COLOR	0	I	II	III	IV	V
ANTRACITA	173851	173857	173862	173868	173874	
CANELA	185408	173847	173853	173859	173865	173870
CAVIAR	185407	173850	173855	173861	173867	173873
CHOCOLATE	173848	173854	173860	173866	173871	
MARINO	173852	173858	173863	173869	173875	



### PANTY ELEGANT

COLOR	0	I	II	III	IV	V
ANTRACITA	173879	173885	173890	173895	173901	
CANELA	185406	173876	173882	173887	173892	173897
CAVIAR	185404	173878	173884	173889	173894	173900
CHOCOLATE	173877	173883	173888	173893	173899	
MARINO	173881	173886	173891	173896	173902	

Para personas que trabajen de pie o sientan pesadez.



### PANTY COMPLET 40

COLOR	P	M	G	EG
NEGRO	315150	314344	314286	315317
VISÓN	311100	311084	311092	311613
CAPUCCINO	301424	301432	302067	302075
CAMEL	311605	311282	311316	311308

## TALLAJE MEDIAS

TOBILLO	P	M	G	EG
PANTORRILLA	20-21 cm	22-23 cm	24-25 cm	26-27 cm
MUSLO	31-33 cm	31-36 cm	37-39 cm	40-42 cm

Nº calzado	35-37	38-40	41-43
Talla	I	II	III

## Media larga y panty

	PESO (en Kg)							
	50-55	55-60	60-65	65-70	70-75	75-80	80-85	85-90
150-155	0	0	I	I	II	III	IV	V
150-160	0	0	I	II	II	III	IV	V
160-165	0	I	I	II	II	III	IV	V
165-170	0	I	I	II	III	III	IV	V
170-175		I	I	II	III	IV	IV	V
175-180			II	II	III	IV	IV	V
180-185				III	III	IV	V	V

COMODIDAD A LA HORA DE VIAJAR



EMO  
CALCETÍN  
VENOSAN

TALLA	Nº DE PIE	JEANS	MADERA	OLIVA	PLATA	NEGRO
S	36-39	098636	098645	098649	098641	098631
M	39-42	098637	098646	098650	098642	098633
L	42-45	098638	098647	098651	098643	098634
XL	45-48	098639	098648	098652	098644	098635



SIGVARIS  
CALCETÍN  
TRAVENO

TALLA	TOBILLO	Nº de pie	CN
S	19-22 cm	35-38	099524
		39-42	099522
		43-46	099521
M	22-24 cm	35-38	099520
		39-42	099519
		43-46	099518
L	24-26 cm	39-42	099517
		43-46	099516

SIN TOMA DE MEDIDAS

10-15 mmHg



SIGVARIS

MEDIA CORTA 70

TALLA	Nº DE PIE	BEIGE	NEGRO
1	36-39	099585	099581
2	39-42	099584	099580
3	42-45	099583	099579
4	45-48	099582	099578



SIGVARIS

MEDIA LARGA 70

TALLA	PESO/ALTURA	BEIGE	NEGRO
1	42-51/150-165	099577	099571
2	52-60/150-173	099576	099570
3	61-69/156-179	099575	099569
4	70-78/162-180	099574	099568
5	79-90/165-180	099573	099567



SIGVARIS

PANTY 70

TALLA	PESO/ALTURA	BEIGE	NEGRO
1	42-51/150-165	099566	099560
2	52-60/150-173	099565	099559
3	61-69/156-179	099563	099558
4	70-78/162-180	099562	099557
5	79-90/165-180	099561	099555

1.2 COMPRESIÓN NORMAL

PARA PERSONAS QUE PASAN MUCHAS HORAS SENTADAS



MEDIA CORTA (A-D)

COLOR	P	M	G	EG	REINA PLUS
NEGRO	306035	306050	307231	307249	176063
BEIGE	331876	331868	331850	331843	176062



CALCETÍN ELÁSTICO (A-D)

COLOR	P	M	G
NEGRO	316646	316653	232413
AZUL	360123	360131	360149

PARA PERSONAS CON MOVILIDAD REDUCIDA Y PROBLEMAS EN LOS PIES: JUANETE, DEDOS GARRA



MEDIA CORTA PUNTERA ABIERTA (A-D)

COLOR	P	M	G	EG
NEGRO	195551	195553	195554	195555
CAMEL	195556	195557	195558	195559



MEDIA LARGA PUNTERA ABIERTA (A-F)

COLOR	P	M	G	EG
NEGRO	195561	195562	195563	195564
CAMEL	195565	195566	195567	195568

PARA PERSONAS CON EXCESO DE SUDORACIÓN



CALCETÍN ANTIBACTERIANO (A-D)

COLOR	P	M	G
NEGRO	162681	162682	162683

PARA PERSONAS QUE TRABAJAN MUCHAS HORAS DE PIE



**MEDIA LARGA BLONDA (A-F)**

COLOR	P	M	G	EG	REINA	REINA PLUS
NEGRO	302083	302091	302109	302117	384099	384107
CAPUCHINO	322628	322800	322818	322974	385146	385161
CAMEL	176064	176066	176067	176068	176069	176490
BEIGE	221846	221853	221861	221879	381780	382788
BLANCO	250412	250411	250414	250413	-----	-----



**PANTY MEDIA ENTERA HASTA LA CINTURA**

COLOR	P	M	G	EG	REINA	REINA PLUS
NEGRO	177287	177279	177261	177253	307793	309294
CAPUCHINO	309336	309708	309732	309740	309765	309302
CAMEL	307413	307496	307710	307728	308221	309310
BEIGE	331385	331827	331819	221887	308981	307801



**Hombre**

**MEDIA LARGA CABALLERO (A-F)**

COLOR	P	M	G	EG
NEGRO	154024	154025	154026	154027



**Hombre**

**PANTY CABALLERO**

COLOR	P	M	G	EG
BEIGE	180802	305102	342998	306696

PARA PERSONAS MUY DELGADAS A LAS QUE SE LES CAE EL PANTY



**PANTY MODELADOR**

COLOR	P	M	G	EG
NEGRO	158256	158255	158257	158258
BEIGE	158259	158260	158262	158263

PARA PERSONAS QUE BUSCAN DISEÑO



**MEDIA CORTA INTELLIGENT PLUS**

COLOR	I	II	III	IV	V
ANTRACITA	173907	173912	173918	173924	173929
CANELA	173904	173910	173916	173921	173927
CAVIAR	173905	173911	173917	173923	173928
MARINO	173908	173913	173919	173925	173931



**MEDIA LARGA INTELLIGENT PLUS**

COLOR	I	II	III	IV	V
ANTRACITA	173935	173940	173945	173951	173957
CANELA	173933	173938	173943	173949	173954
CAVIAR	173934	173939	173944	173950	173956
MARINO	173936	173941	173946	173952	173958

Indicadas para:

- Varicosis primaria y secundaria
- Edemas y alteraciones varicosas
- Insuficiencia venosa crónica
- Post-Quirúrgica



**PANTY INTELLIGENT PLUS**

COLOR	I	II	III	IV	V
ANTRACITA	173962	173968	173974	173979	173984
CANELA	173960	173966	173972	173977	173982
CAVIAR	173961	173967	173973	173978	173983
MARINO	173964	173969	173975	173980	173985

FÁCIL, SIN TOMA DE MEDIDAS



**SIGVARIS MEDIA CORTA 140**

TALLA	Nº DE PIE	BEIGE	NEGRO
1	36-39	099554	099550
2	39-42	099553	099548
3	42-45	099552	099547
4	45-48	099551	099546



**SIGVARIS MEDIA LARGA 140**

TALLA	PESO/ALTURA	BEIGE	NEGRO
1	42-51/150-165	099545	099540
2	52-60/150-173	099544	099539
3	61-69/156-179	099543	099538
4	70-78/162-180	099542	099537
5	79-90/165-180	099541	099536



**SIGVARIS PANTY 140**

TALLA	PESO/ALTURA	BEIGE	NEGRO
1	42-51/150-165	099535	099529
2	52-60/150-173	099534	099528
3	61-69/156-179	099533	099527
4	70-78/162-180	099532	099526
5	79-90/165-180	099530	099525



## 2 TRATAMIENTO

### 2.1 COMPRESIÓN FUERTE

PARA PERSONAS QUE PASAN MUCHAS HORAS SENTADAS



MEDIA CORTA CON PUNTERA CERRADA

COLOR	P	M	G	EG
BEIGE	463711	463729	463737	499996



CALCETIN ELÁSTICO TERAPÉUTICO

COLOR	P	M	G	EG
NEGRO	492967	492975	492983	492991

PARA PERSONAS QUE ADEMÁS, TIENEN PROBLEMAS EN LOS DEDOS O USAN UNA TALLA ELEVADA DE CALZADO



MEDIA CORTA CON PUNTERA CERRADA

COLOR	P	M	G	EG
BEIGE	441238	441246	441253	441261



MEDIA LARGA (A-F)

COLOR	P	M	G	EG
BEIGE	463752	463760	463778	463786

PARA PERSONAS QUE PASAN MUCHAS HORAS DE PIE



MEDIA LARGA BLONDA (A-F)

COLOR	P	M	G	EG	REINA	REINA PLUS
BEIGE	489039	489047	489054	489062	494815	494823



PANTY-MEDIAS LARGAS HASTA LA CINTURA (E-T)

COLOR	P	M	G	EG	REINA	REINA PLUS
BEIGE	463794	463802	463810	463828	480285	489252

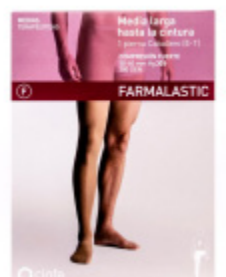

Hombre

PANTY MASCULINO 1 PIERNA HASTA LA CINTURA

COLOR	P	M	G	EG
BEIGE IZQ	476572	476580	476598	476606
BEIGE DCHA	476614	476622	476630	476648



Hombre

PANTY MASCULINO HASTA LA CINTURA

COLOR	P	M	G	EG
BEIGE	476655	476663	476671	476689

## 3 POSTOPERATORIO



THROMBO X  
Compresión  
CCL1  
Calcetín

TALLA	TOBILLO	GEMELO	LARGO	CN
S	18-22 cm	20-35 cm	34-39 cm (N)	099514
			>39 cm (L)	099513
M	22-26 cm	35-40 cm	34-40 cm (N)	099512
			>40 cm (L)	099511
L	26-29 cm	40-45 cm	34-40 cm (N)	099510
			>40 cm (L)	099509
XL	26-29 cm	45-50 cm	34-40 cm (N)	099508
			>40 cm (L)	099506



THROMBO X  
Compresión  
CCL1  
Media larga

TALLA	TOBILLO	GEMELO	MUSLO	LARGO	CN
S	18-22 cm	20-35 cm	43-54 cm	34-39 cm (N)	099505
				>39 cm (L)	099504
M	22-26 cm	35-40 cm	48-60 cm	34-40 cm (N)	099503
				>40 cm (L)	099502
L	26-29 cm	40-45 cm	54-66 cm	34-40 cm (N)	099501
				>40 cm (L)	099500
XL	29-32 cm	40-45 cm	60-72 cm	34-40 cm (N)	099498
				>40 cm (L)	099497

## 4 PRODUCTOS ESTÁNDAR PARA PATOLOGÍA LIMFÁTICA Y EDEMA

### GAMA DE PRODUCTOS MOBIDERM



Si necesitas alguno de estos productos escríbenos a:  
**ortopedia@fedefarma.com**



**COMPREFLEX**  
Dispositivo de compresión ajustable para la pierna

## 5 ACCESORIOS



**SIGVARIS SIMON**  
Pone medias

CN  
0995593



**PRIM**  
Calzador de acero para medias

CN  
078677



**ROLLY**  
Pone medias

CN  
099595



**SIGVARIS**  
Guantes textiles

TALLA	CN
S	099590
M	099589
L	099588
XL	099587

## 11 MOVILIDAD



<b>INTRODUCCIÓN</b> .....	P.100
<b>1. MULETAS</b> .....	P.101
<b>2. BASTONES</b> .....	P.102
<b>3. ACCESORIOS BASTÓN Y MULETA</b> .....	P.105
<b>4. ANDADORES</b>	
4.1 INTERIOR .....	P.106
4.2 EXTERIOR .....	P.109
<b>5. SILLAS</b> .....	P.112
5.1 DE ACERO BÁSICAS .....	P.113
5.2 DE ALUMINIO .....	P.114
5.3 CON RESPALDO RECLINABLE .....	P.114
5.4 BARIÁTRICAS .....	P.114
5.5 ACTIVAS LIGERAS .....	P.115
5.6 BASCULANTES Y RECLINABLES .....	P.115
5.7 DE TRANSFERENCIA .....	P.115
5.8 CONVERTIBLES .....	P.115
<b>6. ACCESORIOS Y SUJECIONES</b> ..	P.116
<b>7. SILLAS ELÉCTRICAS</b> .....	P.118
<b>8. SCOOTERS</b> .....	P.123
<b>9. ACCESORIOS ELÉCTRICOS</b> .....	P.130



Para recomendar cualquier artículo de esta categoría, te recomendamos que indagues en el contexto del paciente:

- Qué **tipo de usuario** es: activo, muy dependiente, altura, peso y condiciones físicas.
- Si es **autónomo** en su día a día: si sale solo a comprar, si pasea, etc
- Cuántas horas al día pasará en la silla.
- Qué **tipo de terreno** es en el que suele moverse: asfalto, camino de tierra, con subidas o bajadas pronunciadas; eso nos dará información sobre la potencia que necesitamos, si es un artículo eléctrico o el tipo de rueda que necesitará.
- Si el usuario tiene **habilidad en las manos**; eso nos dirá qué tipo de freno necesita.
- Importante **medir los huecos de acceso**: ascensor, puerta de entrada, baño, habitación... Todos los sitios por donde deba pasar.
- Igual de importante es saber quién lo usará, como también saber **quién le acompaña**: ¿Tiene fuerza? ¿Hay que cargar la silla diaria o semanalmente en el coche?

De la misma forma, será interesante conocer cómo será el espacio de **almacenamiento del producto**.

Por ello, hemos organizado este tema teniendo en cuenta las distintas necesidades y tipos de pacientes, y de esta forma, puedas adaptar el consejo a cualquier situación.

## 1 MULETAS



**VETTEL ACCES COMFORT**  
 Peso: 485 g  
 Peso máx. usuario: 130 kg  
 Empuñadura muy blanda

ENVASE CN  
 PAR 098360



**VETTEL ERGOTECH**  
 Peso: 540 g  
 Peso máx. usuario: 130 kg  
 Empuñadura plegable

CANTIDAD CN  
 PAR 098361



**VETTEL ERGODYNAMIC**  
 Peso: 600 g  
 Peso máx. usuario: 130 kg  
 Con amortiguación en la empuñadura

TALLA	CANTIDAD	CN
S	PAR	098362
M	PAR	098363
L	PAR	098364



**GARCÍA 2155**  
 Peso máx. usuario: 110 kg  
 Con amortiguador en la base

CANTIDAD CN  
 PAR 097961

### ESTAMPADAS



**GARCÍA 21638**  
 Peso máx. usuario: 130 kg

CANTIDAD CN  
 PAR 097965

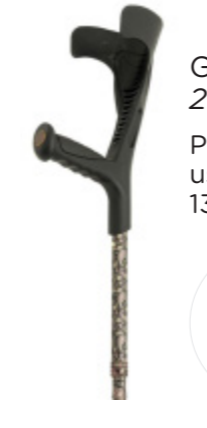

**GARCÍA 21637**  
 Peso máx. usuario: 130 kg

CANTIDAD CN  
 PAR 097963

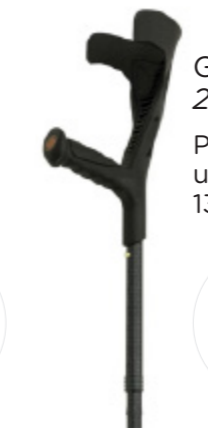

**GARCÍA 21639**  
 Peso máx. usuario: 130 kg

CANTIDAD CN  
 PAR 097962

### CON ABRAZADERA



**GARCÍA 2151**

CANTIDAD CN  
 PAR 099328

### PARA GENTE ALTA



**GARCÍA 2159**

De 89-121 cm  
 1,4 kg 113 kg

CANTIDAD CN  
 PAR 099786

### CON APOYO DE ANTEBRAZO



**MULETA KMINA PRO**  
 Altura de usuario: 150 - 190 cm  
 • Peso máximo de usuario: 100 kg  
 • Altura de la muleta: 96 - 121 cm  
 • Peso de la muleta: 0,996 kg

CANTIDAD CN  
 PAR 086623

Ideal para pacientes crónicos.

Reduce el dolor de hombros.  
 Mejora la postura corporal.  
 Reduce el gasto energético.  
 Aumenta la autonomía.



MULETAS Y BASTONES CUADRÍPODES



GARCÍA 2132

CANTIDAD	CN
UNIDAD	097967



GARCÍA 3521

CANTIDAD	CN
UNIDAD	097968

MULETAS BARIÁTRICAS



GARCÍA 2159XL  
Muleta axilar  
Hasta 180 kg

CANTIDAD	CN
PAR	099292



AYUDAS DINÁMICAS AD103  
Hasta 325 kg  
Ancho de brazo: 15 cm

IZQUIERDA	DERECHA
099441	099442

PLEGABLES ESTAMPADOS



GARCÍA 306

CANTIDAD	CN
UNIDAD	097984



GARCÍA 312

CANTIDAD	CN
UNIDAD	097985



GARCÍA 311

CANTIDAD	CN
UNIDAD	097986



GARCÍA 336

CANTIDAD	CN
UNIDAD	097993



GARCÍA 373

CANTIDAD	CN
UNIDAD	097988



GARCÍA 349

CANTIDAD	CN
UNIDAD	097989

Movilidad

2 BASTONES



KMINA COMFORT  
Negro

CANTIDAD	CN
UNIDAD	086635



KMINA COMFORT  
Bronce

CANTIDAD	CN
UNIDAD	086636



WALKING STICK SOFT STEP  
Empuñadura blanda

COLOR	CANTIDAD	CN
AZUL	UNIDAD	044792
BLANCO	UNIDAD	044677
NEGRO	UNIDAD	044800



THUASNE W2110  
Empuñadura anatómica

LADO	REFERENCIA	CN
DCHA	W2110	099274
IZQ	W2111	099275

EXTENSIBLES



GARCÍA 298

CANTIDAD	CN
UNIDAD	097971



GARCÍA 294

CANTIDAD	CN
UNIDAD	097973



GARCÍA 492  
Mango tacto suave

CANTIDAD	CN
UNIDAD	097978

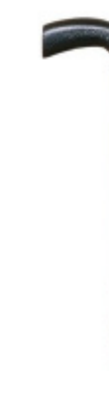

GARCÍA 364

CANTIDAD	CN
UNIDAD	097979



GARCÍA 420

CANTIDAD	CN
UNIDAD	097980

CLÁSICOS DE MADERA



GARCÍA 81

CANTIDAD	CN
UNIDAD	097981



GARCÍA 1243

CANTIDAD	CN
UNIDAD	097982

←..... Haya .....→



GARCÍA 3421

CANTIDAD	CN
UNIDAD	097969



GARCÍA 164

CANTIDAD	CN
UNIDAD	097970

←..... Aluminio .....→



Puños de madera



GARCÍA 423

CANTIDAD	CN
UNIDAD	097974



GARCÍA 345

CANTIDAD	CN
UNIDAD	099331



GARCÍA 465

CANTIDAD	CN
UNIDAD	097975



GARCÍA 466

CANTIDAD	CN
UNIDAD	097976



GARCÍA 473

CANTIDAD	CN
UNIDAD	097977

CON LINTERNA



GARCÍA 480

CANTIDAD	CN
UNIDAD	099329



GARCÍA 482

CANTIDAD	CN
UNIDAD	099330

SERIE ECO (mango suave)



GARCÍA 954

Extensible

CANTIDAD	CN
UNIDAD	097990

Extensible



GARCÍA 901

Plegable

CANTIDAD	CN
UNIDAD	097991

Plegable

SERIE MINI PLEGABLE



GARCÍA 3315

CANTIDAD	CN
UNIDAD	097992



GARCÍA 3313

CANTIDAD	CN
UNIDAD	030371

ESPECIAL LLUVIA



GARCÍA 1463

Bastón extraíble en caso de lluvia

CANTIDAD	CN
UNIDAD	097983

EXPOSITORES



GARCÍA 795

Gratis con la compra de 6 bastones

CANTIDAD	CN
UNIDAD	097994



GARCÍA 789

CANTIDAD	CN
UNIDAD	097995

3 ACCESORIOS BASTÓN Y MULETAS



GARCÍA 2153G

ENVASE	CN
PAR	099446



GARCÍA 815

Para muletas

DIÁMETRO	CN
19 mm	097996



GARCÍA 814

Para bastón de madera

DIÁMETRO	CN
16 mm	097997
18 mm	097999



GARCÍA 825

DIÁMETRO	CN
14mm	098011

Para personas que se sientan inseguras y, además, iel bastón se aguanta de pie!



GARCÍA 819

Para muletas

DIÁMETRO	CN
17 mm	098000
19 mm	098001
21 mm	098002



GARCÍA 8201

DIÁMETRO	CN
19 mm	098005



GARCÍA 820

DIÁMETRO	CN
19 mm	098003



GARCÍA 844

Base muy ancha

DIÁMETRO	CN
19 mm	098006



GARCÍA 8301

Clip sujeta bastón

ENVASE	CN
unidad	098014



GARCÍA 810

Asa para cordón

Negro

ENVASE	CN
unidad	098015



GARCÍA 8101

Asa para cordón

Marrón

ENVASE	CN
unidad	098016

## 4 ANDADORES

### 4.1 ANDADORES DE INTERIOR

#### DE INCORPORACIÓN, DEAMBULADORES Y FIJOS



**GARCÍA 2108**  
Andador de incorporación 2 niveles  
Con opción de orinal

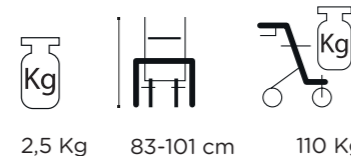
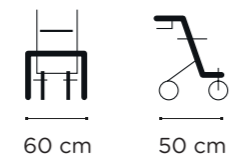

CN  
098018



**GARCÍA 2109**  
Con opción orinal

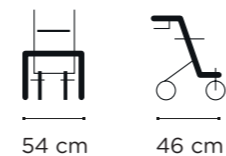

CN  
098019



**GARCÍA 21081**  
Orinal para andador

CN  
098022



**GARCÍA 2111**  
Andador deambulador plegable Aluminio  
Permite andar sin tener que levantar el peso del andador

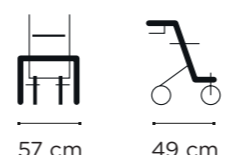

CN  
098021



**GARCÍA 2107**  
Andador de aluminio fijo

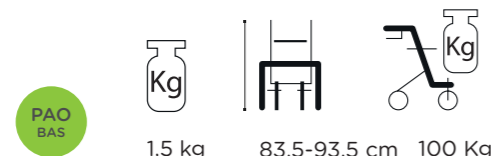
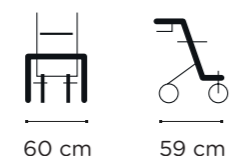

CN  
098017

#### CON ASIENTO



**KMINA COMFORT**  
2 ruedas  
Con cojín viscoelástico

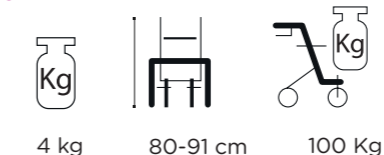
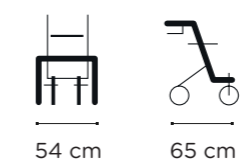

CN

086627



**FORTA KAMALEÓN**

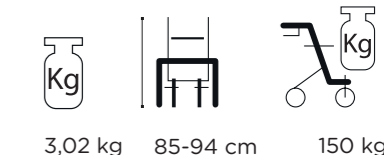
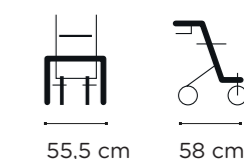

COLOR

CN

AZUL

098837

#### CON ASIENTO Y RUEDAS



**FORTA KIT KAMALEÓN**  
Kit de ruedas traseras para andador kamaleón

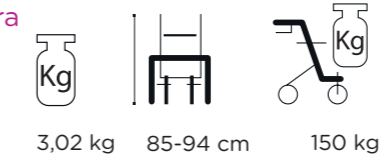
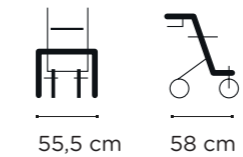

CN

KIT

098838

#### DE ACERO



**FORTA AIR-ON ZERO**  
Para usuarios con poca estabilidad

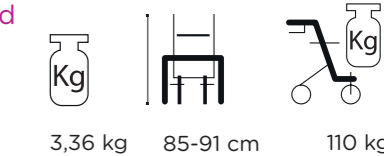
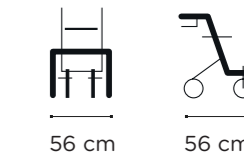

COLOR

CN

AZUL

098835

#### PARA USUARIOS DE >1,80 m



**FORTA CAR**

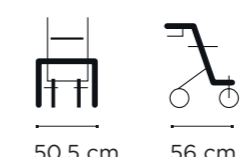

COLOR

CN

AZUL

098836



**GARCÍA 2214N**  
Regulable de 48 a 53 cm

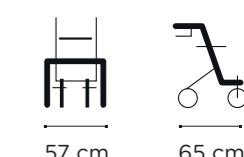

COLOR

CN

GRIS

099327

CONVERTIBLES

FORTA AIR

Con 6 accesorios

¡Complétalo con los que necesites!



CN

039483

ALTO: 85 a 91 cm

LARGO: 56 cm

ANCHO: 48,5 cm

LARGO PLEGADO: 26,5 cm

DIAMETRO RUEDA: 4 x 15 cm

PESO: 2,560 kg

RESISTENCIA: 100 kg

ACCESORIOS CN

CESTA	099368
KIT DE RUEDAS	099370
MESA	099369



Si necesitas cambiar los puños del andador, ¡ESCRÍBENOS! [ortopedia@fedefarma.com](mailto:ortopedia@fedefarma.com)



4.2 ANDADORES DE EXTERIOR: ROLATORS

CON FRENOS POR PRESIÓN



GARCÍA 2221

La cesta puede colocarse en la parte delantera

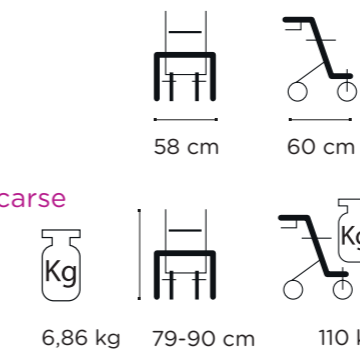

CN

098023

Para los que no tengan fuerza en las manos.



KMINA COMFORT

¡Con cojín viscoelástico!

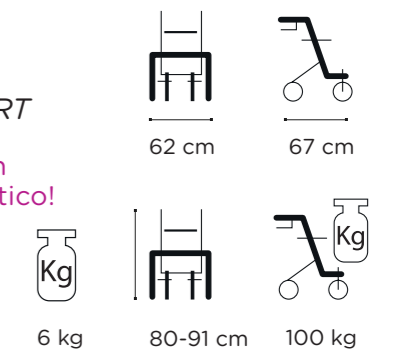

CN

099427

CON FRENOS EN LA EMPUÑADURA



KMINA COMFORT  
Freno con maneta

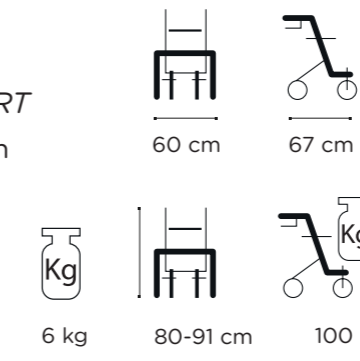

CN

086626



GARCÍA 2222

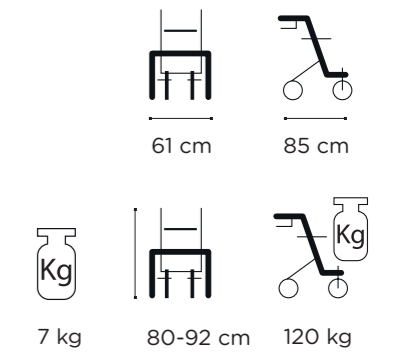

CN

098024



THUASNE QUATRO

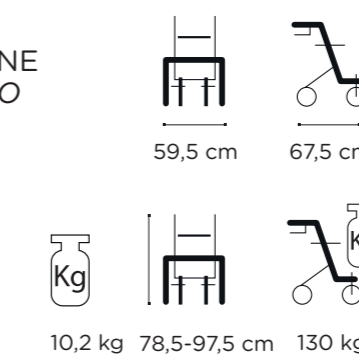

COLOR CN

GRIS	099272
AZUL	099271

DE TALLAJE PEQUEÑO



AYUDAS DINÁMICAS AD185

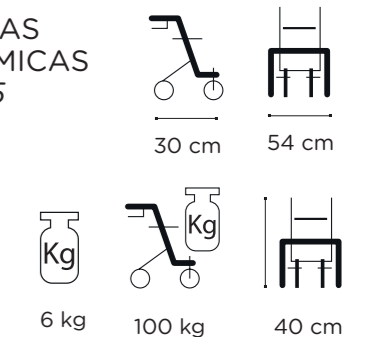

CN

047808

CON ASIENTO Y EMPUÑADURA REGULABLES



GARCÍA  
22271

¡Para los  
más altos!

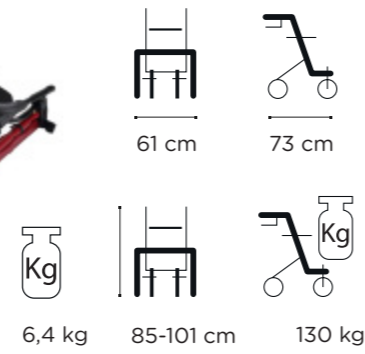

CN

098025

ESPECIAL COMPRA



GARCÍA  
2218

COLOR CN  
ESTAMPADO 098028  
NEGRO 098027



GARCÍA  
22181



FORTA  
PELÍKANO

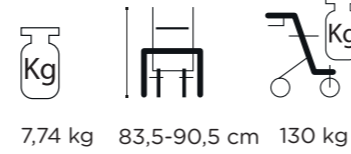

COLOR CN  
GRIS 098840

CON BANDEJA



GARCÍA  
2223

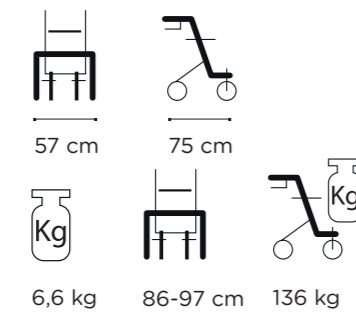

CN

098029



KMINA  
PRO  
NEGRO



KMINA  
PRO  
AZUL

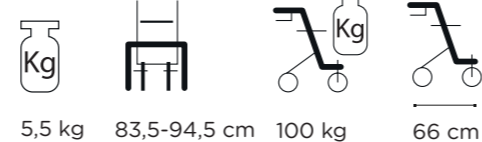

COLOR CN  
AZUL 086695  
NEGRO 086624

ESTILOS MODERNOS



VERMEIREN  
QUAVA

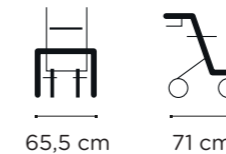

COLOR CN  
CARBÓN 098717  
ROJO 098716

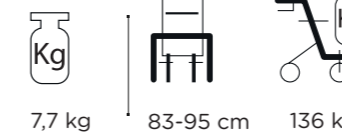

GARCÍA  
22251

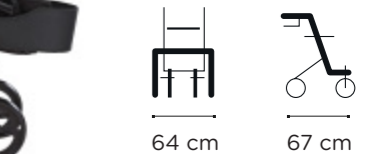

COLOR CN  
PLATEADO 099367

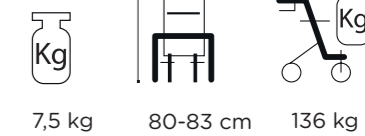

ROLATORS-SILLA

Ideal para usuarios que  
andan pero se cansan.



GARCÍA  
2226

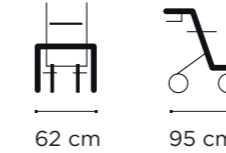

CN

098030



GARCÍA  
22261  
COMFORT

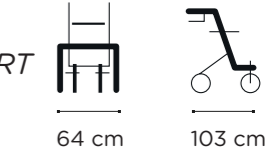

CN

098031



PARA USUARIOS CON PESO ELEVADO



Si necesitas algún modelo de silla  
o andador no propuesto en este  
catálogo, no dudes en escribirnos a:  
[ortopedia@fedefarma.com](mailto:ortopedia@fedefarma.com)



VERMEIREN  
GOLIAT

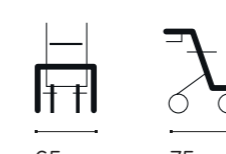

COLOR CN  
ROJO 099613  
PLATA 099615

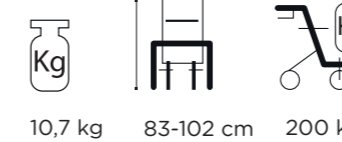

FORTA  
KANGURO  
MAXI

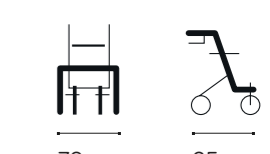

COLOR CN  
AZUL 098839

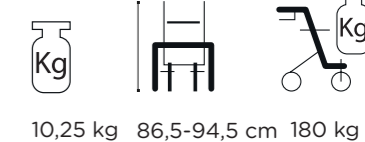



CON REPOSABRAZOS ABATIBLES



GARCÍA 2243

- Peso neto: 10,6 Kg
- Ruedas traseras 30 cm

Rueda trasera de 300 mm

PAO BAS

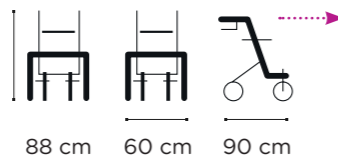

CN 098032



GARCÍA 2242

- Peso neto: 11,5 Kg
- Ruedas traseras 50 cm

Rueda trasera de 300 mm

PAO BAS



CN 098042

5.1 DE ACERO



VERMEIREN JAZZ

Rueda trasera de 600 mm

PAO BAS

TALLA	RUEDA 600	RUEDA 300
39	098718	098725
42	098719	098726
44	098720	098727
46	098721	098728
48	098722	098729
50	098724	098730



VERMEIREN JAZZ

Rueda trasera de 300 mm

PAO BAS

- Reposabrazos abatibles y extraíbles
- Reposapiés extraíbles y abatibles
- Ruedas traseras extraíbles: "quick release"
- Altura de asiento regulable en 2 posiciones

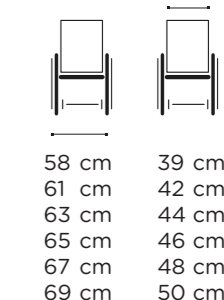
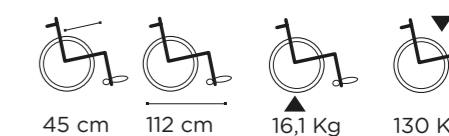

En común:

- Aluminio+tapicería nylon
- Respaldo plegable
- Freno en la empuñadura
- Reposapiés extraíbles, plegables y abatibles
- Altura del asiento: 48 cm
- Medidas asiento: 45 x 36 cm
- Ruedas delanteras giratorias (15cm)
- Peso máximo del usuario: 100kg

MEDIDAS PLEGADO

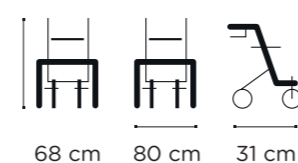

REPOSABRAZOS FIJOS



GARCÍA 2238

- Peso neto: 12 Kg
- Ruedas traseras 30 cm

Rueda trasera de 300 mm

PAO BAS

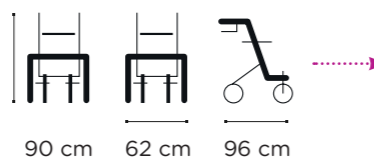

CN 098047



GARCÍA 2237

- Peso neto: 12,4 Kg
- Ruedas traseras 50 cm

Rueda trasera de 600 mm

PAO BAS



CN 098048



GARCÍA 2233

Reposapiés para piernas escayoladas

! STOCK

CN 099326

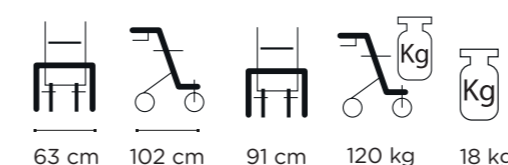

VERMEIREN D100

PAO BAS

! STOCK

- Empuñaduras regulables en altura
- Altura de asiento regulable en 3 posiciones
- Reposabrazos abatibles y extraíbles
- Los acolchados de los reposabrazos se regulan en profundidad
- Reposapiés abatibles y extraíbles

El asiento se puede bascular un poco para evitar deslizamientos

TALLA	RUEDA 600	RUEDA 300
38	098732	098738
40	098733	098739
42	098734	098740
44	098735	098741
46	098736	098742
48	098737	098743
50	-----	098745
52	-----	098746

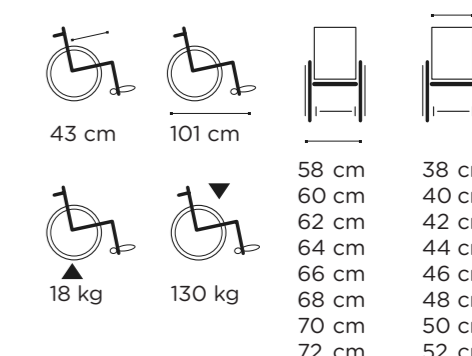

### 5.2 DE ALUMINIO



GARCÍA 2240

Quick release con ruedas antivuelco

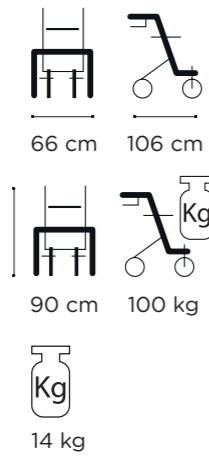

TALLA	CN
46	098049



VERMEIREN ECLIPS X2

Con frenos en la empuñadura



TALLA	CN	TALLA	CN
38	098747	44	098751
40	098748	46	098752
42	098750	48	098753

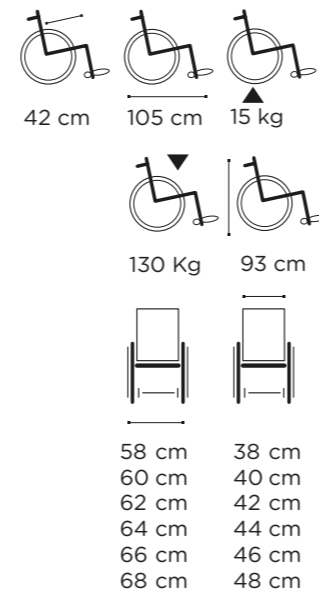

### 5.5 ACTIVA LIGERA



VERMEIREN TRIGO

Para usuarios activos con patología medular.



- Ruedas traseras extraíbles
- Respaldo ajustable en tensión
- Reposabrazos regulables y extraíbles
- Opcionalmente con ajuste de altura
- Reposapiés abatibles hacia dentro y fuera
- Paletas (reposapiés) regulables en ángulo

MODELO	CN
TRIGO-S	098777
TRIGO-T	098778

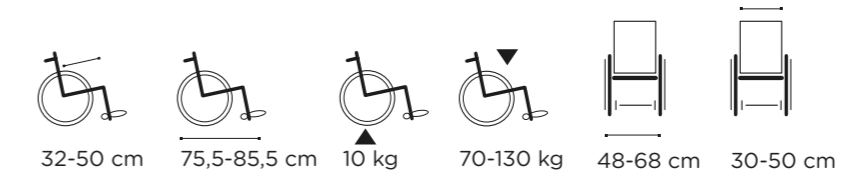

Al ser productos muy configurables, te recomendamos contactarnos en lugar de realizar el pedido por terminal.

### 5.3 CON RESPALDO RECLINABLE



VERMEIREN D100 30°

- Reclinación 30°
- Empuñaduras regulables en altura
- Altura de asiento regulable en 3 posiciones
- Reposabrazos abatibles y extraíbles
- Los acolchados de los reposabrazos se regulan en profundidad
- Reposapiés abatibles y extraíbles

Se necesitan ruedas antivuelco.

ANCHO	RUEDA 600	RUEDA 300	TALLA	CN	TALLA	CN
38	098754	098762	46	098759	098767	
40	098755	098763	48	098760	098768	
42	098757	098765	50	098761	098769	
44	098758	098766				

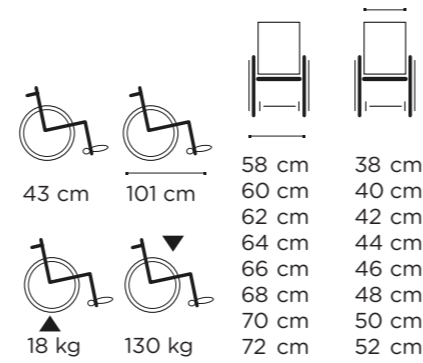

### 5.4 BARIÁTRICAS

Para usuarios con peso elevado.



VERMEIREN V100

Acero

- Barra de empuje anti torsión
- Altura de asiento regulable en 3 posiciones
- Doble cruceta

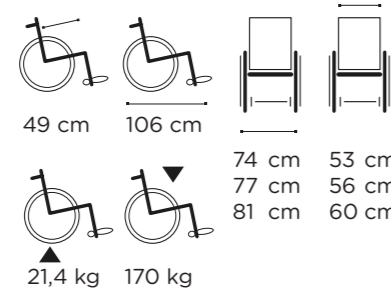

ANCHO	RUEDA 600
53	098770
56	098771
60	098773



VERMEIREN V300 XL

Aluminio

- Barra de empuje anti torsión
- Altura de asiento regulable en 4 posiciones
- Respaldo regulable en tensión
- Doble cruceta

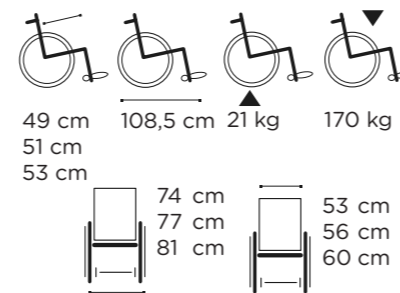

ANCHO	RUEDA 600
53	098774
56	098775
60	098776



### 5.7 TRANSFERENCIAS/TRANSPORTE



TEYDER 1426SR

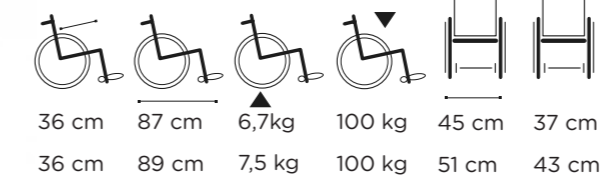

TALLA	CN
36	098450
43	098451

### 5.8 CONVERTIBLES



FORTA LINE DÚO

¡2 en 1!  
Elige entre rueda grande o pequeña según convenga



TALLA	CN	TALLA	CN
38	098841	48	098844
41	098842	52	098845
45	098843	56	098846

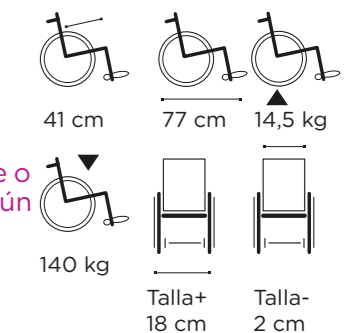



**GARCÍA 2579**  
Chubasquero con mangas

CN  
098050



**GARCÍA 2578**  
Poncho impermeable

CN  
098052



**GARCÍA 2580**  
Saco térmico con forro polar

CN  
098054



**QBIO**  
Manta termo impermeable

TALLA	MEDIDAS	CN
M	90x105 cm	098663
L	105x120 cm	098664
XL	120x130 cm	098666



**VERMEIREN B14**  
Prolongación de respaldo

TALLA	MODELO	CN
38	D100	098793
40	D100	098794
42	D100	098795
44	D100	098796
46	D100	098797
50	D100	098880
52	D100	098801

TALLA	MODELO	CN
38	D100-30	098802
39	JAZZ S50	098803
40	D100-30	098804
42	JAZZ+D100-30	098805
44	JAZZ+D100-30	098807
46	JAZZ+D100-30	098808
48	JAZZ+D100-30	098809
50	JAZZ+D100-30	098810



**GARCÍA 2575**  
Mesa para silla de ruedas  
**Universal**

TALLA	CN
U	098055



**GARCÍA 836**  
Soporte para bastones

ENVASE	CN
unidad	098013



**VETTEL AD17**  
Chaleco perineal silla

TALLA	PERÍMETRO	CN
M	60-95 cm	098342
L	95-135 cm	098344



**VETTEL AD12**  
Cinturón abdominal perineal

TALLA	LONGITUD	CN
0	40 cm	098341
1	56 cm	098340

1,50 m longitud total.  
Cierre con hebilla



**VETTEL AD11**  
Cinturón abdominal

TALLA	LONGITUD	CN
0	40 cm	098339
1	56 cm	098338

1,50 m longitud total.  
Cierre con hebilla



**VERMEIREN BP7**  
Reposapiernas yeso

UNIDADES	CN
PAR	098827



**GARCÍA 822**  
Para andador

DIÁMETRO	CN
22 mm	098008
25 mm	098009
28 mm	098010



**QBIO Saniluxe grafito**  
Cubresilla acolchado

TALLA	MEDIDAS	CN
S	40x50x40 cm	098669
M	45x50x42 cm	098668
L	52x50x45 cm	098667



**QBIO**  
Manguitos térmicos calentamanos

MODELO	CN
CUADROS	098675
GRAFITO	098674



**VETTEL ADX 40**  
Cojín posicionador lumbar

CN
098337



**VERMEIREN B78**  
Ruedas antivuelco

MODELO SILLA	CN
STANDARD	098792
INNOVYS	098791



**VERMEIREN BZ8**  
Reposapiés elevable

TALLA	DCHO	IZQ
38	098818	098812
39-42	098819	098813
44	098820	098815
46	099299	098816
48-50	098821	098817



**TEYDER IFS52G**  
Reposacabezas acolchado

TALLA	CN
U	098457



**AYUDAS DINÁMICAS PLCAB**  
Reposacabezas plegable

TALLA	CN
U	048234



**QBIO 106321**  
Protector reposabrazos

unidades	CN
PAR	098670



**QBIO 106351**  
Protector lateral

unidades	CN
PAR	098672



**QBIO 707100**  
Protector para reposapiés

unidades	CN
PAR	098671

## 7 SILLAS ELÉCTRICAS

 Para pedidos, demostraciones, dudas, o consultas sobre otras medidas, por favor, ponte en contacto con nosotros: [ortopedia@fedefarma.com](mailto:ortopedia@fedefarma.com)

 Para pedidos, demostraciones, dudas, o consultas sobre otras medidas, por favor, ponte en contacto con nosotros: [ortopedia@fedefarma.com](mailto:ortopedia@fedefarma.com)



### VERMEIREN TURIOS

Peso máximo usuario 130 kg

Possibilidad de numerosos accesorios intercambiables



 10 km/h

 105,8 kg

 107 x 58 x 102 cm

 35 km

- Silla compacta
- Potente tracción trasera
- Configurable a petición del usuario
- Profundidad de asiento ajustable
- Doble batería



### KARMA EFLEXX

Peso máximo usuario 100 kg

Plegado muy compacto, ideal para transportar



 8 km/h

 33 kg

 110 x 55 x 85 cm

 20 km

- Homologada para ser usada como asiento en vehículo de motor
- Partes móviles de color naranja para una mayor intuición
- Reposabrazos abatible y ajustable
- Reposapiés abatible y desmontable
- Opción rueda grande/pequeña



### TEYDER DISCOVER

Peso máximo usuario 120 kg

Control remoto por bluetooth



 6 km/h

 19,5 kg sin baterías

 85,5 x 60,5 x 95,5 cm

 20 km

- Estructura de aluminio plegable
- Respaldo graduable en tensión
- Fácil de maniobrar y transportar
- Baterías de litio de 22Ah
- Luz led incorporada
- Plegado y desplegado eléctrico con mando



### TEYDER SPA

Peso máximo usuario 180 kg

Plegado rápido en 5 segundos



 6 km/h

 26,5 kg

 99 x 59 x 92 cm

 25 km

- Control frontal del estado de las baterías
- Funciona con una o dos baterías que se pueden cargar en la silla o fuera de ella
- Ideal para transportar
- Fabricada en aluminio ligero
- Asiento desmontable y lavable (a más de 95°)
- Ruedas anti pinchazo y suspensión
- Altura del suelo 11,5 cm: lo que permite que sea todoterreno
- Motor silencioso
- Posibilidad de colocar mando para acompañante

 Para pedidos, demostraciones, dudas, o consultas sobre otras medidas, por favor, ponte en contacto con nosotros: [ortopedia@fedefarma.com](mailto:ortopedia@fedefarma.com)



#### APEX I-DISCOVER

Peso máximo usuario 150 kg

Robusta y a la vez ultraligera



 5-7 km/h

 34 kg

 103 x 61 x 103 cm

 15 km

- Respaldo hidráulico reclinable 35°
- Reposapiés regulable en altura y ángulo
- Reposabrazos ajustable en altura y profundidad
- Tres modos de conducción: ECO, Normal y Sport
- Suspensiones que evitan la vibración del pavimento
- Plegado con una sola mano



#### APEX I-STAR

Peso máximo usuario 115 kg

Silla con plegado más compacto del mercado



 4-6 km/h

 26,9 kg

 96 x 64 x 87 cm

 15 km

- Se pliega y despliega con su mando a distancia
- Muy compacta, mide 96 cm de largo
- Con su reposapiés plegable permite al usuario acceder a la silla de forma frontal

 Para pedidos, demostraciones, dudas, o consultas sobre otras medidas, por favor, ponte en contacto con nosotros: [ortopedia@fedefarma.com](mailto:ortopedia@fedefarma.com)



#### APEX I-EXPLORER XL3

Peso máximo usuario 180 kg



 6 km/h

 37,2 kg

 105 x 69,5 x 98,5 cm

 30 km

- Ruedas traseras de 12"
- Sistema de aviso mediante voz
- Ideal para espacios reducidos y para viajar gracias a sus dimensiones compactas
- 3 modos de conducción: Eco, Normal y Sport
- Reposapiés ajustable en altura para una mejor adaptación al usuario
- Suspensiones que aportan una mayor comodidad y evitan las vibraciones del pavimento
- Plegado instantáneo y ruedas traseras que permiten transportarla como una trolley



#### APEX I-EXPLORER 4

Peso máximo usuario 115 kg

Ideal para espacios reducidos y viajes



 5-7 km/h

 29 kg

 102 x 61 x 96,5 cm

 15 km

- Sistema de aviso mediante voz
- 3 modos de conducción: Eco, Normal y Sport
- Reposapiés abatible, lo que permite la entrada frontal a la silla
- Suspensiones que aportan una mayor comodidad y evitan las vibraciones del pavimento
- Ideal para espacios reducidos y para viajar gracias a sus dimensiones compactas
- Plegado instantáneo y ruedas traseras que permiten transportarla como una trolley

Sillas eléctricas más ligeras del mercado:

Para pedidos, demostraciones, dudas, o consultas sobre otras medidas, por favor, ponte en contacto con nosotros: [ortopedia@fedefarma.com](mailto:ortopedia@fedefarma.com)



**TECMOVING JOYTEC**

Peso máximo usuario 120kg

- 9,5 km/h
- 21 kg
- 13 km

- Plegado fácil
- Ocupa espacio mínimo
- Control sencillo por joystick
- Ligera y fácil de transportar
- Cinturón de seguridad
- Cesta inferior
- Reposapiés basculante, lo que facilita el acceso a la silla
- Ruedas antivuelco
- Potencia en subidas
- Doble motor

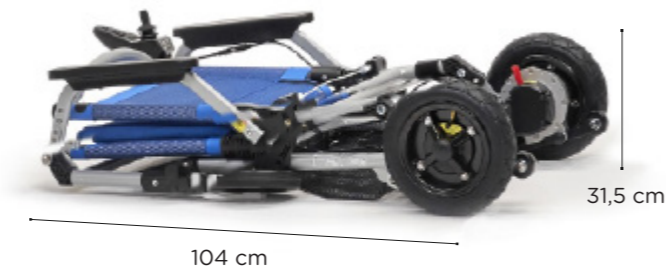

Freno electromagnético. Si el joystick se soltara, la silla quedaría automáticamente frenada, tanto si ocurre en subida como en bajada.



**TECMOVING ZINGER CLASSIC**

Peso máximo usuario 113kg

Conducción con palancas. Imprescindible tener movilidad en las dos manos y una buena coordinación

- 6 km/h
- 18 kg
- 13 km



- Chasis de aluminio
- Plegado fácil, resistente y ligera
- Carga rápida
- Reposapiés basculante, lo que facilita el acceso a la silla
- Ruedas anti vuelco
- Ruedas delanteras de nylon macizas y ruedas traseras de nylon con neumático
- Batería de alta duración
- Luces anti reflectantes traseras

8 SCOOTERS

Para pedidos, demostraciones, dudas, o consultas sobre otras medidas, por favor, ponte en contacto con nosotros: [ortopedia@fedefarma.com](mailto:ortopedia@fedefarma.com)

**I-Transformer**

Motor 120 W / Batería 10 Ah

Dimensiones: 96 x 51,5 x 88 cm



La más ligera y compacta. Apta para personas que no se pueden agachar para plegar.

**Plegado electrónico por mando remoto**

**I-Brío Plus**

Motor 270 W / Batería 11,5 Ah

Desplegada: 96 x 53 x 87-100 cm

Desplegada c/ apoyabrazos : 96 x 55,5-58 x 87-100 cm



Personas que pueden usar un pie para plegar y se conforman con algo más básico. Radio reducido.

**Plegado manual**

**I-Láser**

Motor 270 W / Batería 14,5 Ah

Dimensiones desplegada: 91 x 60 x 80-90 cm

Dimensiones plegada: 48 x 60 x 80 cm



**Plegables**

Para entrar en ascensores sin plegar (solo 91 cms). Máxima estabilidad (anchura 60 cms).

**Plegado electrónico**

**I-Nano**

Motor 200 W / Baterías 18Ah

Dimensiones: 99 x 52 x 86 cm



**No plegables / desmontables**

DESMONTABLES: Para personas que desean transportar su scooter en un coche, aunque sea ocasionalmente. Autonomía media y presupuesto ajustado. Puedes llevarte sus baterías a casa para recargar. Ruedas macizas.

**I-Confort**

Motor 250 W / Baterías 22 Ah

Dimensiones: 112 x 62 x 93,5 cm



**I-Tauro**

Motor 500 W / Baterías 36 Ah

Dimensiones: 120 x 62 x 119 cm



**No plegables / no desmontables**

La mejor relación peso-potencia, muy robusta y de ruedas neumáticas. Necesita toma de corriente cercana para la recarga de las baterías.

**Objetivo:**

- tamaño

**Portabilidad, viajar**

**Reto arquitectónico interior**

- Portal difícil
- Ascensor pequeño

**Objetivo:**

+ rendimiento

**Potencia** motor (W)

**Capacidad** baterías (Ah)

**Reto arquitectónico exterior**

- Abundancia de cuevas (\*)
- Trazados exigentes (\*)

(\*) Leer siempre máximos recomendados según manual usuario

 Para pedidos, demostraciones, dudas, o consultas sobre otras medidas, por favor, ponte en contacto con nosotros: [ortopedia@fedefarma.com](mailto:ortopedia@fedefarma.com)



**APEX I-TAURO**

Peso máximo usuario 136 kg

Potente motor de 500 W y dos baterías de 36 Ah

Ideal para pequeñas excursiones

 8 km/h

 87 kg

 120 x 62 x 119 cm

 34 km



Palanca de desembrague y ruedas anti vuelco

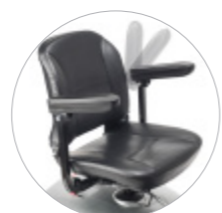

Reposabrazos abatibles



Columna de conducción

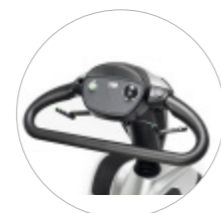

Mando ergonómico



Kit de luces delanteras



Asiento regulable en profundidad

**Accesorios:**



Funda de almacenaje



Baúl delantero



Porta bastones



Cesta trasera

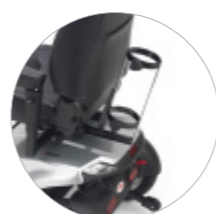

Soporte botella de oxígeno

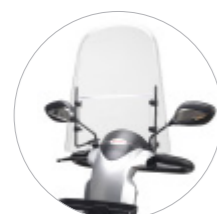

Paravientos



Bolsa trasera con porta bastones doble

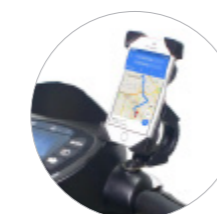

Soporte para móvil

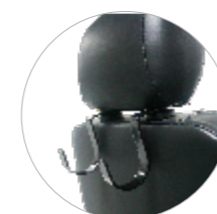

Colgadores para bolso



Cargador USB



**APEX I-CONFORT**

Peso máximo usuario 136 kg

Fácil transporte

Ideal para personas con problemas de espalda, por sus amortiguadores y ruedas altas

 8 km/h

 55 kg

 112 x 59 x 93,5 cm

 25 km



Reposabrazos abatibles



Mando ergonómico



Luz led delantera



Amortiguación trasera



Baterías extraíbles para facilitar su recarga



Desmontable en 4 piezas



Columna de conducción

**Accesorios:**



Funda de almacenaje



Porta bastones

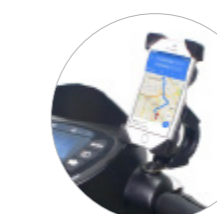

Soporte para móvil



Retrovisores



Cargador USB

 Para pedidos, demostraciones, dudas, o consultas sobre otras medidas, por favor, ponte en contacto con nosotros: [ortopedia@fedefarma.com](mailto:ortopedia@fedefarma.com)



APEX  
I-LASER  
Peso máximo  
usuario 115 kg  
Compacta y potente  
Plegable  
automáticamente

- 6 km/h
- 35 kg
- 91 x 60 x 80-90 cm
- 18 km



Botón de plegado de fácil acceso



Pantalla multifunción y llave de proximidad

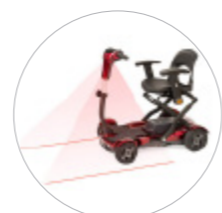

El láser indica el espacio de seguridad necesario para circular

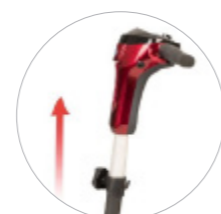

Manillar ergonómico y regulable en altura



Luces LED delanteras y traseras

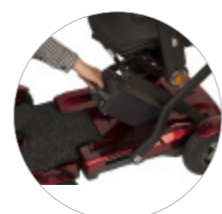

Batería de litio extraíble (14,5 Ah) para facilitar su carga

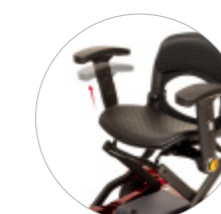

Reposabrazos abatibles y regulables en altura y anchura

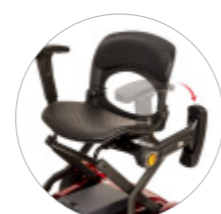

Ruedas neumáticas y anti vuelco



APEX  
I-BRIO PLUS  
Peso máximo  
usuario 115 kg

Ruedas anti vuelco para mayor seguridad  
Fácil transporte, permite moverla como una trolley

Plegado instantáneo al presionar el pedal

- 6,5 km/h
- 34 kg
- 96 x 53 x 87-100 cm
- 13 km

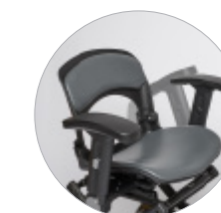

Reposabrazos abatibles y regulables en altura y anchura

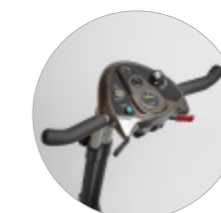

Manillar ergonómico



Desmontable en 3 piezas



Batería de litio extraíble para facilitar su carga



Luz LED delantera



Palanca de desembague y ruedas anti vuelco. Luz trasera

Accesorios:



Bolsa trasera



Cesta inferior

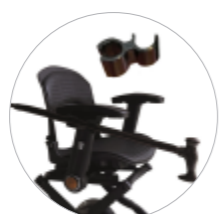

Porta bastones giratorio



Cinturón de seguridad



Cesta delantera

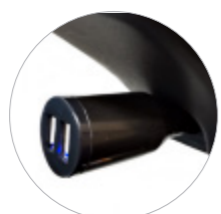

Cargador USB



Para pedidos, demostraciones, dudas, o consultas sobre otras medidas, por favor, ponte en contacto con nosotros: [ortopedia@fedefarma.com](mailto:ortopedia@fedefarma.com)

Accesorios:



Bolsa transporte



Cesta inferior



Cesta delantera

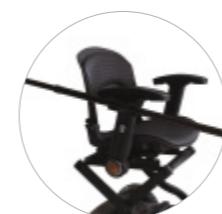

Porta bastones Smart

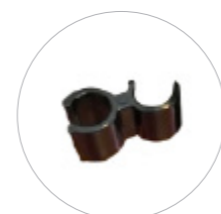

Porta bastones giratorio



Cargador USB



Para pedidos, demostraciones, dudas, o consultas sobre otras medidas, por favor, ponte en contacto con nosotros: [ortopedia@fedefarma.com](mailto:ortopedia@fedefarma.com)



 Para pedidos, demostraciones, dudas, o consultas sobre otras medidas, por favor, ponte en contacto con nosotros: [ortopedia@fedefarma.com](mailto:ortopedia@fedefarma.com)



**APEX I-NANO**

Peso máximo usuario 130 kg

Fácil de transportar, ya que se desmonta en cuatro piezas

Muy compacta, solo 99 cm de largo 63,5 cm de ancho

 8 km/h

 52 kg

 102 x 54 x 90 cm

 18 km

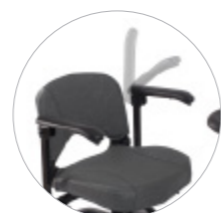

Reposabrazos abatible



Mando ergonómico



Baterías extraíbles para facilitar su recarga



Columna de conducción

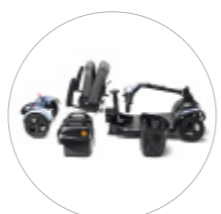

Desmontable en 4 piezas



Palanca de desembrague y ruedas anti vuelco



Luz led delantera



**APEX I-TRANSFORMER**

Peso máximo usuario 120 kg

Ligera, cómoda y fácil de transportar

Sólo 25 kg de peso, baterías incluidas

 6 km/h

 25 kg

 96 x 51,5 x 88 cm

 12 km



Pulsar el mando a distancia para plegar y desplegar.



Plegado eléctrico automático.



Manillar se repliega para almacenar.



Transportable como un trolley apoyándose en las ruedas delanteras.

**Accesorios:**



Funda de almacenaje



Porta bastones

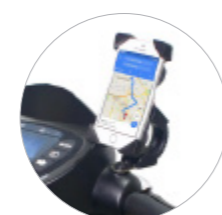

Soporte para móvil



Retrovisores

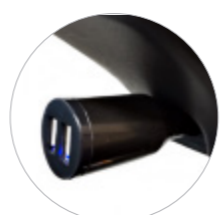

Cargador USB

**Accesorios:**



Base externa



Bolsa transporte



Maleta de viaje



Cesta plegable



Luz delantera y trasera



Cargador USB

 Para pedidos, demostraciones, dudas, o consultas sobre otras medidas, por favor, ponte en contacto con nosotros: [ortopedia@fedefarma.com](mailto:ortopedia@fedefarma.com)

## 9 ACCESORIOS ELÉCTRICOS PARA SILLAS Y SCOOTERS:

Para pedidos y demostraciones escribir a:  
[ortopedia@fedefarma.com](mailto:ortopedia@fedefarma.com)



### APEX GRÚA HÉRCULES

Peso máximo soportado 45 kg

Permite levantar y bajar sillas y scooters hasta 45 kg

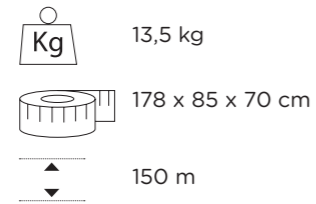

- Se puede meter en el coche con sólo presionar un botón
- Perfecta para transportarla y guardarla cómodamente
- Pedal de freno para evitar que la grúa se mueva
- Puede ser utilizada con la batería de la scooter o con su batería externa (no incluida)\*

\* Para ser utilizada con sillas habrá que hacer uso de la batería externa para suministrar la potencia suficiente.

#### Accesorios:



### APEX BATERÍA EXTERNA GRÚA HÉRCULES

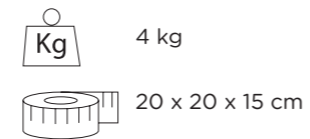

- Potencia hasta 300 W
- Doble rueda
- Posición de plegado para cuando no se utiliza
- Marcha atrás y adelante
- Palanca de funcionamiento



### TEYDER POWER PACK PLUS

Peso máximo usuario 159 kg

Adaptable al 99% de las sillas del mercado

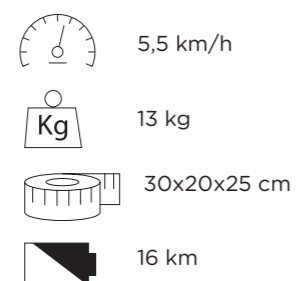

ANCHO	LARGO	ALTO	CN
200mm	300mm	245mm	098456

## 12 AYUDAS

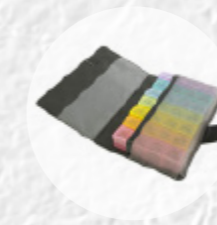

### 1. BAÑO

- 1.1 ASIDERAS.....P.133
- 1.2 ELEVADORES Y BIDETS.....P.133
- 1.3 TABLAS DE TRANSFERENCIA.....P.134
- 1.4 TABURETES Y SILLAS.....P.134
- 1.5 ACCESORIOS DE BAÑO.....P.136

### 2. INCORPORACIÓN/ MOVILIZACIÓN DE PACIENTES

- 2.1 CINTURONES Y SÁBANAS DE TRANSFERENCIA.....P.137
- 2.2 DISCOS GIRATORIOS.....P.137
- 2.3 PATAS DE ELEFANTE.....P.137
- 2.4 SILLONES.....P.138
- 2.5 TRAPECIOS Y GRÚAS.....P.138
- 2.6 ARNESES.....P.139

### 3. DESCANSO

- 3.1 COJINES Y ALMOHADAS.....P.140
- 3.2 CAMAS.....P.140
- 3.3 BARANDILLAS Y MESAS.....P.141
- 3.4 SUJECIONES DE CAMA.....P.142

### 4. INCONTINENCIA

- 4.1 PIJAMAS.....P.143
- 4.2 ROPA INTERIOR.....P.143
- 4.3 ORINALES Y CUÑAS.....P.144
- 4.4 EMPAPADORES.....P.144

### 5. COTIDIANAS/MEDICACIÓN

- 5.1 PASTILLEROS.....P.145
- 5.2 PINZAS Y CALZADORES.....P.145
- 5.3 UTENSILIOS DE COCINA.....P.146
- 5.4 BABEROS.....P.147

## 1 BAÑO

## 1.1 ASIDERAS



GARCÍA  
21940  
RIVER  
Asidera

## LONGITUD

31 cm

## CN

098056

41 cm

098057



GARCÍA  
21781  
Barra abatible  
cromada

## LONGITUD

18x10,5x74 cm

## CN

098058

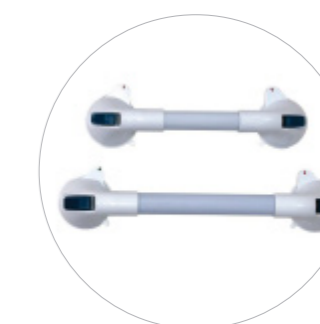

GARCÍA  
2199030/  
2199040  
Asidera con  
ventosa

## LONGITUD

30 cm

## CN

098059

40 cm

098060

## 1.2 ELEVADORES Y BIDETS

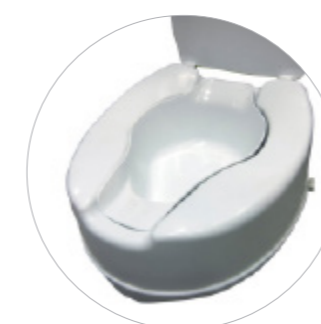

GARCÍA  
2280  
Bidet  
adaptable  
a WC o alzas

## MEDIDAS

8x21,5x35,5 cm

## CN

098070



GARCÍA  
2278  
Elevador  
WC  
Sin tapa

## ALTURA

10 cm

## CN

098072

15 cm

098076



GARCÍA  
2279  
Elevador  
WC  
Con tapa

## ALTURA

10 cm

## CN

098074

15 cm

098077



GARCÍA  
22801  
Bidet  
adaptable  
estándar

## MEDIDAS

41x37x12cm

## CN

098071

1.3 TABLAS DE TRANSFERENCIA

1.4 TABURETES Y SILLAS



**GARCÍA 2183**  
Tabla de transferencia bañera

LONGITUD	CN
75 cm	098061



**GARCÍA 21871**  
Asiento giratorio de bañera universal en forma de U

Aluminio

CN
098078



**GARCÍA 2186**  
Asiento giratorio de bañera universal

Acero inoxidable

CN
098080



**AYUDAS DINÁMICAS AD831 SWIFT**  
Taburete y silla

MAX Kg  
Kg  
130 kg 4,7 kg

ASIENTO

ANCHO	FONDO	ALTO	ANCHO TOTAL	FONDO TOTAL	RESPALDO	CN
46 cm	41 cm	42-57 cm	54 cm	50 cm	40 cm	046968



**AYUDAS DINÁMICAS AD830 SWIFT**  
Taburete

MAX Kg  
Kg  
130 kg 3,1 kg

ASIENTO

ANCHO	FONDO	ALTO	ANCHO TOTAL	CN
46 cm	41 cm	42-57 cm	54 cm	047215



**GARCÍA 2299**  
Banqueta con asiento giratorio

MAX Kg  
Kg  
140 kg 21 kg

CN

098062



**GARCÍA 2290**  
Banqueta acolchada  
Con respaldo

MAX Kg  
Kg  
100 kg 2'8 kg  
42 cm 49 cm

CN

098065



**GARCÍA 2291**  
Banqueta acolchada  
Sin respaldo

MAX Kg  
Kg  
100 kg 2 kg  
42 cm 49 cm

CN

098068



**AYUDAS DINÁMICAS AD520 ACUARIO**  
Silla de baño

MAX Kg  
Kg  
100 kg 3,8 kg

ASIENTO

ANCHO	FONDO	ALTO	ANCHO TOTAL	FONDO TOTAL	ALTO TOTAL	CN
40 cm	40 cm	46-53 cm	53 cm	55 cm	82-89 cm	046531



**AYUDAS DINÁMICAS AD832 SILLA SWIFT**  
3 en 1:  
Elevador  
Silla con inodoro  
Silla para la ducha

MAX Kg  
Kg  
130 kg 5,4 kg

ASIENTO

ANCHO	FONDO	ALTO	ANCHO TOTAL	FONDO TOTAL	ALTO TOTAL	CN
46 cm	41 cm	42-57 cm	54 cm	50 cm	80-95 cm	047418



**GARCÍA 2197**  
Banqueta de aluminio

MAX Kg  
Kg  
110 kg 3 kg  
40 cm 55 cm

CN

098069



**GARCÍA 21881**  
Asiento plegable con patas  
Regulable en altura: 46-53 cm

MAX Kg  
110 kg

CN

098064



**GARCÍA 2196**  
Silla aluminio con brazos

MAX Kg  
Kg  
110 kg 3,5 kg  
46 cm 53 cm

CN

098063



**GARCÍA 2211**  
Silla inodoro tapizada  
Regulable en altura

MAX Kg  
Kg  
125 kg 53 cm 50 cm

CN

098081



**AYUDAS DINÁMICAS AD809-LEVINA NEW**

MAX Kg  
Kg  
120 kg 12 kg

ASIENTO

ANCHO	FONDO	ALTO	ANCHO TOTAL	CN
44 cm	42 cm	54 cm	55 cm	048107



**GARCÍA 2169**  
Silla con inodoro y ruedas  
Con bloqueo en ruedas traseras

MAX Kg  
Kg  
120 kg 7 kg 52 cm 52 cm

CN

098082



AYUDAS  
DINÁMICAS  
AD828  
SILLA ETAC

Ideal traslados:  
Habitación-baño  
Elevador-ducha-  
silla con inodoro

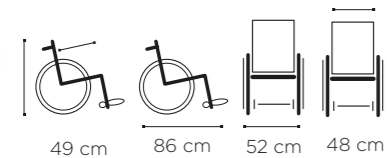

CN

047072



VERMEIREN  
PLUO



150 kg 9.7 kg



72 cm 57 cm

CN

099612



GARCÍA  
2234

Silla de baño

Autopropulsable



110 kg 12.9 kg



65 cm 52 cm

CN

098083

## 1.5 ACCESORIOS DE BAÑO



GARCÍA  
2415

Esponja para pies

Con  
ventosa  
para un  
agarre total

CN

098084



GARCÍA  
2314

Cepillo

Con  
mango  
extraíble

CN

098085

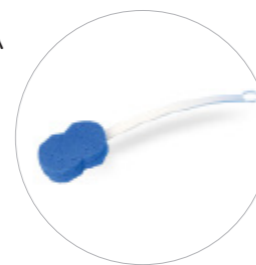

GARCÍA  
2300

Esponja con mango

CN LONGITUD

098086 59 cm

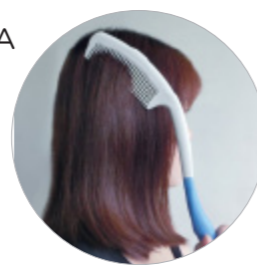

GARCÍA  
2304

Peine largo ergonómico

CN

098089



GARCÍA  
2303

Cepillo largo ergonómico

CN

098088



GARCÍA  
2331

Lavacabezas hinchable

Para lavado  
en cama

CN

098090



GARCÍA  
2332

Lavacabezas de plástico

Para lavado  
en silla

CN

098091

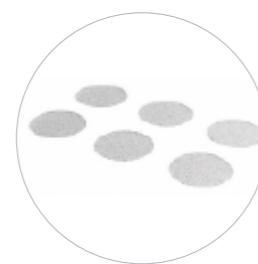

VETTEL  
SEC-800

Círculos para la ducha

UNIDADES

CN

32 098358



VETTEL  
SEC-820

Tiras para la ducha

UNIDADES

CN

12 098359

## 2 INCORPORACIÓN/MOVILIZACIÓN DE PACIENTES

### 2.1 CINTURONES Y SÁBANAS DE TRANSFERENCIA



UBIOTEX  
Cinturón  
movilizador

Para levantar a la persona  
de manera más cómoda.

TALLA	CONTORNO	REFERENCIA	CN
M	65-115 cm	306585	098677
L	95-155 cm	306587	098678
XL	110-170 cm	306589	098679



GARCÍA  
2552  
Cinturón  
movilizador

MEDIDAS	CN
79-163 cm	098096

Para el transporte de pacientes.



UBIOTEX  
306605  
Sábana tubular  
deslizante

Para la  
movilización  
de pacientes  
encamados.

MEDIDAS	CN
75x130 cm	098676



UBIOTEX  
306600  
Manta  
movilizadora  
de traslado  
standard

MEDIDAS	CN
77x102 cm	098680

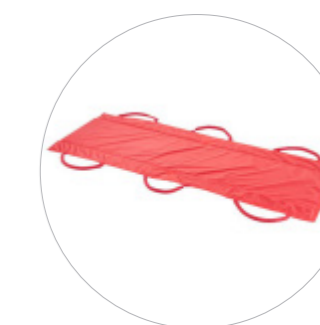

GARCÍA  
2553  
Sábana de  
transferencia

MEDIDAS	CN
53x150 cm	098094

### 2.2 DISCOS GIRATORIOS



GARCÍA  
2999  
Disco  
giratorio

CN

098092



115 kg 1 kg



GARCÍA  
3000  
Asiento giratorio

Para que el  
paciente se  
siente y pueda  
rotar, por ejemplo,  
al colocarse en  
el coche

CN

098093



135 kg

### 2.3 PATAS DE ELEFANTE

¿Sabías que al levantarse de una posición a 90°, la fuerza que ejercen las rodillas es igual al peso del usuario x 4?



GARCÍA  
2270  
Patas de  
elefante  
Madera

ALTURA	CN
9 cm	098101



GARCÍA  
2271  
Patas de  
elefante  
Madera

ALTURA	CN
14 cm	098102

## 2.4 SILLONES



## Especificaciones técnicas

Dimensiones plegadas (largo x ancho x alto)	101 x 84 x 70 cm
Peso del producto	48 kg
Largura total al extender el sillón	163 cm
Medidas del asiento (largo x ancho)	46 x 47 cm
Altura del apoyabrazos hasta el suelo	61,1 cm
Respaldo (ancho x alto)	54 x 58 cm
Motor	100 - 240V, 50 - 60 Hz, 1,5A
Peso máximo soportado	130 kg
Garantía	2 años

## 2.5 TRAPECIOS Y GRÚAS

GARCÍA  
2800

Grúa eléctrica

Elevación y  
traslado

CN

098098

Su función es levantar, erguir o transferir a un paciente de la cama hacia otro punto donde apoyarse o, lugar, como un sofá, camilla o silla de ruedas

- Estructura de acero.
- Ruedas traseras con freno de 10 cm. Ruedas delanteras de 7,6 cm
- Con pedal para abrir la base para permitir el acceso a butacas o sillones
- Sistema de parada y de caída de emergencia
- Rango elevación de la percha: 72 cm a 173 cm
- Longitud del brazo de la percha: 99 cm. Altura del mástil: 119 cm
- Ancho de la base regulable con pedal: 49 a 72 cm. Largo: 112 cm
- Entrada de alimentación: 220VAC/50HZ

GARCÍA  
2801

Grúa eléctrica

Bipedestación  
y traslado

CN

098099

Pensada para facilitar la incorporación de la cama o desde una silla, siempre que el paciente tenga suficiente fuerza en las extremidades inferiores para sujetar en parte su propio peso. Este tipo de grúa se utiliza principalmente para ayudar al cuidador a vestir, cambiar de ropa, lavar y hacer una transferencia sencilla a una silla.

GARCÍA  
21681Incorporador  
de cama con  
trapecio

CN

098100

## 2.6 ARNESES

GARCÍA  
2810

CN

098518

Arnés económico de fácil uso y ajuste rápido, ideal para transferencias hacia o desde una posición sentada. Debe ser utilizado en pacientes con control cefálico. Compatible con grúas de 2 o 4 ganchos.

GARCÍA  
2811

CN

098519

Arnés universal envolvente con apoyo cefálico y cinturón abdominal de ajuste rápido de 118 cm. Tiene una amplia apertura para facilitar el posicionamiento en el inodoro, facilitar la limpieza, etc. Compatible con grúas de 2 o 4 ganchos.

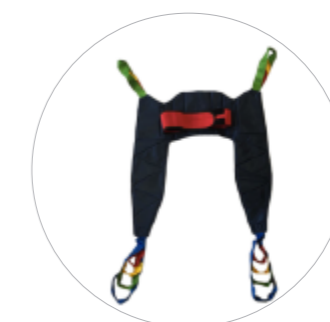
GARCÍA  
2812

CN

098520

Arnés universal con cinturón abdominal de ajuste rápido. Tiene una amplia apertura para facilitar el posicionamiento en el inodoro, facilitar la limpieza, etc. Debe ser utilizado en pacientes con control cefálico. Compatible con grúas de 2 o 4 ganchos.

GARCÍA  
2813

CN

098521

Arnés de cuerpo entero con reposacabezas y zona perineal libre para que la higiene del paciente sea más cómoda. Recomendable en transferencias más delicadas, ya que el paciente apoya su cabeza, dándole una mayor sensación de seguridad.

GARCÍA  
2814

CN

098522

Arnés de cuerpo entero con apoyo cefálico acolchado y respaldo reforzado. Cuenta con un orificio para el inodoro. Compatible con grúas de 2 o 4 ganchos.

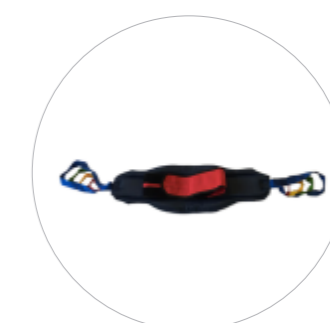
GARCÍA  
2815

CN

098523

Arnés de bipedestación. Adaptable a prácticamente todas las grúas de bipedestación por tracción anterior. Permite la transferencia de la persona de una manera cómoda y sencilla.

## 3.1 COJINES Y ALMOHADAS



QBIO  
602401  
Almohada  
cervical  
visco

MEDIDAS	CN
70x30x10 cm	098654



GARCÍA  
3010  
Almohada  
cervical

MEDIDAS	CN
51x31x10 cm	097943



QBIO  
106525  
Cojín de  
lectura

MEDIDAS	CN
72x37x13/25 cm	098682



QBIO  
604250  
Almohada  
anti-reflujo

MEDIDAS	CN
50x70x30 cm	098684



QBIO  
608100  
Cuña reposa  
piernas

MEDIDAS	CN
40x70x20 cm	098683



GARCÍA  
3038  
Cojín  
separador

MEDIDAS	CN
24x20x14 cm	098104

## 3.2 CAMAS



Para medidas especiales, pedidos e información sobre condiciones de montaje y transporte, ¡escribenos! [ortopedia@fedefarma.com](mailto:ortopedia@fedefarma.com)



GARCÍA  
30200/30201  
Somier articulado  
eléctrico

REFERENCIA	MEDIDAS	CN
30200	190x90 cm	098105
30201	190x105 cm	098106



GARCÍA  
30210/30211  
Somier  
articulado  
elevable  
**Con ruedas**

REFERENCIA	MEDIDAS	CN
30210	190x90 cm	098107
30211	190x105 cm	098108



VERMEIREN  
ILLICO  
Cama con  
carro  
elevador

Ideal para alquiler. Se monta y desmonta en pocos minutos y sin herramientas. Peso máximo: 170 kg (paciente y colchón). Par de barandillas incluidas.

MEDIDAS	CN
200x90	098789
Pack colchón (200x90 cm)	099674



VERMEIREN  
LUNA  
Cama con  
carro elevador  
**Elevada seguridad**

MEDIDAS	CN
190x90 cm	098790

## 3.3 BARANDILLAS Y MESAS



GARCÍA  
2264  
Juego de  
barandillas  
abatibles

CANTIDAD	CN
PAR	098109

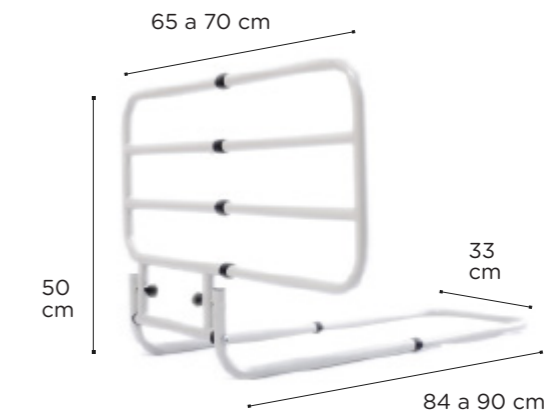

GARCÍA  
22601  
Asidera y  
barandilla  
de cama

CN
098110



GARCÍA  
2263  
Protector  
de barandilla  
acolchado

MEDIDAS	CN
140x40 cm	099433



GARCÍA  
2168  
Mesa auxiliar  
plegable

CN
098112



GARCÍA  
2167  
Mesa auxiliar  
abatible y  
regulable en  
altura

MEDIDAS	CN
82x38 cm	098524

## 3.4 SUJECIONES DE CAMA



**VETTEL  
AD51**  
Cinturón de  
sujeción a  
cama

TALLA	MEDIDAS	CN
S	40-60 cm	098345
M	60-100 cm	098346
L	100-140 cm	098347



**VETTEL  
AD61**  
Muñequera  
de sujeción  
a cama

TALLA	CN
U	098348



**VETTEL  
AD66**  
Tobillera  
de sujeción  
a cama

TALLA	CN
U	098349



**VETTEL  
AD90**  
Sábana  
fantasma adulto  
manga larga

TALLA	CN
U	099417



**VETTEL  
AD56P**  
Cinturón  
pélvico  
con cierre  
magnético

TALLA	CONTORNO	CN
1	40-60 cm	099362
2	60-100 cm	099363
3	100-140 cm	099364



**VETTEL  
AD67**  
Tobillera con  
cierre magnético

TALLA	CN
U	099366



**VETTEL  
AD62P**  
Muñequera  
con cierre  
magnético

TALLA	CN
U	099365

## 4 INCONTINENCIA

## 4.1 PIJAMAS



**QBIO**  
Pijama  
antipañal  
manga  
larga

TALLA	CN
S	098692
M	098693
L	098694
XL	099609



**QBIO**  
Pijama  
antipañal  
manga  
corta

TALLA	CN
S	098688
M	098689
L	098690
XL	098691



**QBIO**  
Pijama  
antipañal  
corto

TALLA	CN
S	098686
M	099611
L	099610
XL	098687

## MEDIDAS (cm)

TALLA	PECHO	CINTURA	CADERA	TIRO
S	100 cm	97 cm	110 cm	82 cm
M	104 cm	102 cm	112 cm	85 cm
L	112 cm	112 cm	122 cm	87 cm
XL	120 cm	125 cm	128 cm	90 cm
XXL	140 cm	140 cm	148 cm	100 cm

## 4.2 ROPA INTERIOR



**GARCÍA  
3052**  
Ropa interior  
hombre  
incontinencia

TALLA	MEDIDAS	CN
S	64-72 cm	098526
M	76-80 cm	098113
L	82-92 cm	098114



**GARCÍA  
3054**  
Ropa interior  
mujer  
incontinencia

TALLA	MEDIDAS	CN
S	58-70 cm	098530
M	72-80 cm	098115
L	82-92 cm	098116



**QBIO**  
Braga  
sujeta pañal  
impermeable

TALLA	CINTURA	MUSLO	CN
S	66-93 cm	43-60 cm	098696
M	73-112 cm	53-72 cm	098697
L	89-133 cm	61-85 cm	098698
XL	95-140 cm	65-95 cm	098700
XXL	108-150 cm	74-100 cm	098701



## 4.3 ORINALES Y CUÑAS



GARCÍA  
2383  
Orinal  
masculino

VOLUMEN CN  
1L 098117



GARCÍA  
2384  
Orinal  
masculino  
con tapa

VOLUMEN CN  
1L 098118



GARCÍA  
2385  
Orinal  
femenino

VOLUMEN CN  
1L 098119



GARCÍA  
2386  
Porta  
orinales

CN  
098130



GARCÍA  
2382

CN  
098131

## 4.4 EMPAPADORES



CALVO  
IZQUIERDO  
Empapadores

MEDIDAS CN  
60x40 cm 098333  
60x60 cm 098334  
60x90 cm 098336



GARCÍA  
3040  
Empapador  
silla reutilizable  
5 capas

MEDIDAS CN  
45x50 cm 098132

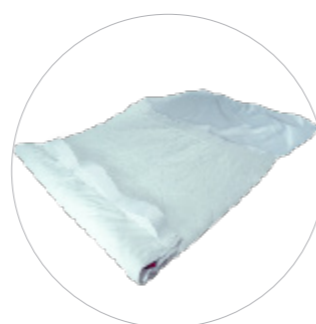

QBIO  
205850  
Empapador-  
volteador

MEDIDAS CN  
90x85 cm 098702

## 5 COTIDIANAS

## 5.1 PASTILLEROS



GARCÍA  
23121  
Triturador de  
comprimidos

CN  
098133



GARCÍA  
2312  
Triturador y  
partidor de  
comprimidos

CN  
098134



GARCÍA  
2311  
Parte  
comprimidos

CN  
098135



GARCÍA  
2313  
Pastillero  
circular 7  
días

CN  
098136



GARCÍA  
23172  
Pastillero  
semanal  
2 tomas  
diarias

CN  
098137

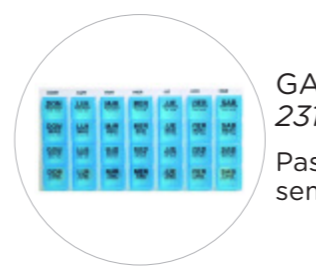

GARCÍA  
2317  
Pastillero  
semanal

CN  
098139

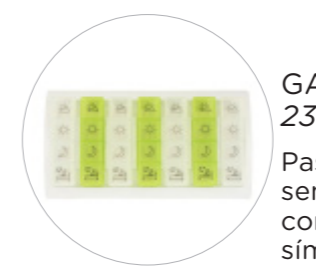

GARCÍA  
23171  
Pastillero  
semanal  
con  
símbolos

CN  
098138

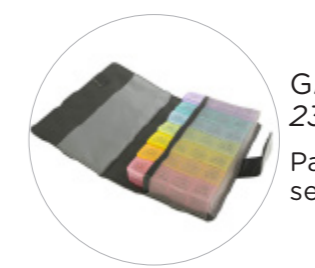

GARCÍA  
2316  
Pastillero  
semanal

CN  
098141



GARCÍA  
2318  
Pastillero  
diario 4  
tomas

CN  
098142

## 5.2 PINZAS Y CALZADORES



GARCÍA  
2145  
Pinza  
ultraligera  
de aluminio

CN  
098143



PRIM  
U-187  
Calzador  
para zapatos

CN  
163929



GARCÍA  
23091  
Calzador  
regulable

CN  
098144



GARCÍA  
2505  
Llavero  
girador  
de 3 llaves

CN  
098153



GARCÍA  
2341  
Banqueta  
agarre  
seguro

CN

098166



GARCÍA  
2320

CN

098154



GARCÍA  
2321

CN

098155



GARCÍA  
2322

CN

098156



GARCÍA  
2433  
Pajita sin  
retroceso

CN

098157



GARCÍA  
2429  
Vaso  
ergonómico  
figura nariz

CN

098158



GARCÍA  
2431

CN

098159



GARCÍA  
2420  
Borde  
elevado que  
facilita el  
apoyo de los  
alimentos

CN

098161



CN

098163



GARCÍA  
2481  
Multiabridor  
standard



GARCÍA  
2325  
Borde  
de plástico  
para platos

CN

098162

5.4 BABEROS



GARCÍA  
2319  
Babero  
reutilizable  
impermeable

CN

098164



QBIO  
704404  
Babero  
estampado  
cuadros

CN

189370



QBIO  
704400  
Babero  
estampado  
puzzle

CN

189369



THUASNE  
AD150  
Babero  
impermeable  
con cierre de  
lazo

CN

098350

# 13 ANTIESCARAS



INTRODUCCIÓN..... P.150

1. ALMOHADAS ESPECIALES..... P.151

2. LÁMINAS PROTECTORAS ..... P.151

3. CODERAS, PATUCOS Y MANOPLAS..... P.151

4. COJINES ANTIESCARAS ..... P.152

5. COLCHONES ANTIESCARAS..... P.153



ÚLCERAS POR PRESIÓN: UPP

PARA RECOMENDAR UN PRODUCTO ANTIESCARAS  
¡UTILIZA LA ESCALA DE BRADEN!

¿De qué se trata?

La escala de braden es un método de puntos que permite valorar el riesgo de ulceración que puede tener un paciente analizando 6 parámetros de riesgo, otorgando a cada uno entre 1 y 4 puntos, de la siguiente forma:

MEDIDAS	1 PUNTO	2 PUNTOS	3 PUNTOS	4 PUNTOS
Percepción sensorial	Completamente limitada	Muy limitada	Ligeramente limitada	Sin limitación
Exposición a la humedad	Siempre húmeda	A menudo húmeda	Ocasionalmente húmeda	Raramente húmeda
Actividad física deambulación	Encamado	En silla	Deambula ocasionalmente	Deambula frecuentemente
Movilidad cambios posturales	Inmóvil	Muy limitada	Levemente limitada	Sin limitación
Nutrición	Muy pobre	Probablemente inadecuada	Adecuada	Excelente
Cizallamiento y roce	Riesgo máximo	Riesgo potencial	Sin riesgo aparente	

RIESGO BAJO: 15 PUNTOS O MÁS

RIESGO MODERADO O INTERMEDIO: 13 O 14 PUNTOS

RIESGO ALTO O ELEVADO: MENOS DE 12 PUNTOS

1 ALMOHADAS ESPECIALES



QBIO 106175  
Protector post-operatorio de oreja

CN  
098655

2 LÁMINAS PROTECTORAS



CQF ALIVIOVISCO  
Rollo viscoelástico  
Dureza media

CN  
099722

3 CODERAS PATUCOS Y MANOPLAS



VETTEL AD79  
Talonera suapel blanco

CN  
098353



VETTEL AD76  
Talonera-codera

CN  
098352



QBIO SANILUXE  
Patucos verano

ENVASE PAR CN 189350



PRIM  
Talonera-codera

ENVASE PAR CN 074025



GARCÍA 30011  
Bota confort antiescaras

CN  
097957



THUASNE CARE PROTECT  
Patuco

TALLA	PERÍMETRO	CN
1	27-31 cm	099276
2	32-36 cm	099277
3	37-42 cm	099278



QBIO Manopla suapel marino

TALLA	CN
S	098656
M	189358
L	098658



QBIO Manopla transpirable grafito

TALLA	CN
S	098659
M	098660
L	098661

## 4 COJINES ANTIESCARAS

PREVENCIÓN

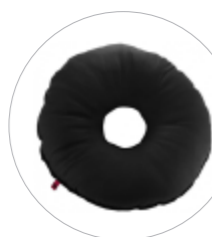

**QBIO 114100**  
Cojín saniluxe redondo con agujero

CN

189335



**QBIO 114115**  
Cojín saniluxe cuadrado con agujero

CN

189337



**QBIO 114110**  
Cojín saniluxe herradura cuadrada

CN

189336

### VISCO BÁSICO

PUNTUACIÓN ESCALA DE BRADEN:

16-23

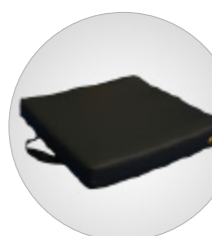

**EMO CV040**  
Cojín cuadrado



MEDIDAS CN  
40x40x6 cm 098621

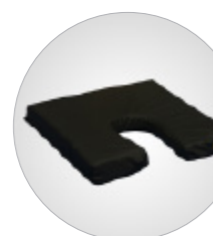

**EMO CV340**  
Cojín herradura



MEDIDAS CN  
40x40x6 cm 098622



**EMO CV140**  
Cojín cuadrado



MEDIDAS CN  
40x40x6 cm 098623



**EMO CV240**  
Cojín herradura



MEDIDAS CN  
40x40x6 cm 098625

### GEL DE FLOTACIÓN LÍQUIDA

13 A 15

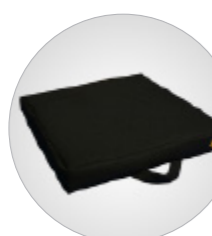

**EMO CF140**  
Cojín cuadrado



MEDIDAS CN  
40x40x6 cm 098626



**EMO CF240**  
Cojín herradura



MEDIDAS CN  
40x40x6 cm 098627



**QBIO 102428 ERGOGEL COMPLEX**



MEDIDAS CN  
42x42x8 cm 189344

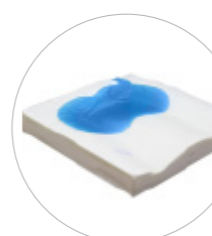

**APEX VISCOGEL 0112011**



MEDIDAS CN  
41 x 41 cm 099005

### COJINES DE AIRE

10 A 12



**APEX CONFORM 01160006**



MEDIDAS CN  
43 x 43 x 7,5 cm 099006

Con celdas y fundas de algodón



**APEX SEDENS 400**



MEDIDAS CN  
44x41x9 cm 099007

- Compuesto de 6 celdas de foam
- Con una válvula inteligente que permite ajustar la presión para un correcto posicionamiento en sillas de ruedas

6 A 9



**APEX SEDENS 500**



MEDIDAS CN  
41x42 cm 099008

- Con cuatro celdas de presión alternante
- Compresor silencioso y de fácil uso
- Disponible en otras medidas: 43x43 cm y 46x46 cm



Si necesitas otras medidas o buscas algún artículo que no aparece en el catálogo, escríbenos a: [ortopedia@fedefarma.com](mailto:ortopedia@fedefarma.com)

## 5 COLCHONES ANTIESCARAS

Antiescaras

PREVENCIÓN



**CQF CF240 ERGOFOAM 28**

MEDIDAS CN  
190x105x15 cm 099790  
190x90x15 cm 099779



**APEX DOMUS 1**  
Sobrecolchón

MEDIDAS CN  
198 x 86 x 6,4 cm 099009

16-23



**APEX DOMUS 1/S**  
Sobrecolchón

16 celdas de PVC sanitario de 12,5 cm

Peso: 3,1 kg  
Máxima salida de aire: 4 l/minuto  
Duración del ciclo alternante: 9,6 min

MEDIDAS CN  
200x85x12,5-9 cm 099011

13 A 15



**APEX DOMUS 2**  
Sobrecolchón

18 celdas de PVC sanitario de 10,2 cm

Peso: 4 kg  
Máxima salida de aire: 4 l/minuto  
Duración del ciclo alternante: 9,6 min

MEDIDAS CN  
200x80x10,2 cm 099012

10 A 12



**APEX DOMUS 3**  
Colchón

17 celdas independientes de nylon PU de 12,7 cm

Peso: 5,6 kg  
Máxima salida de aire: 8 l/minuto  
Duración del ciclo alternante: 10 min

MEDIDAS CN  
200x85x12,7 cm+5 de foam 099013

6 A 9



**APEX DOMUS 4**  
Colchón

Con 3 tipos de terapia:  
- De presión alternante,  
- De baja presión continua y  
- Anti-cizalla  
20 celdas independientes de nylon PU de 20,32 cm

Peso: 5,6 kg  
Máxima salida de aire: 8 l/minuto  
Duración del ciclo alternante: 10 min

MEDIDAS CN  
200x85x20,32 cm 099014



Si necesitas otras medidas o buscas algún artículo que no aparece en el catálogo, escríbenos a: [ortopedia@fedefarma.com](mailto:ortopedia@fedefarma.com)

**14** PATOLOGÍA RESPIRATORIA/  
PRODUCTOS VARIOS

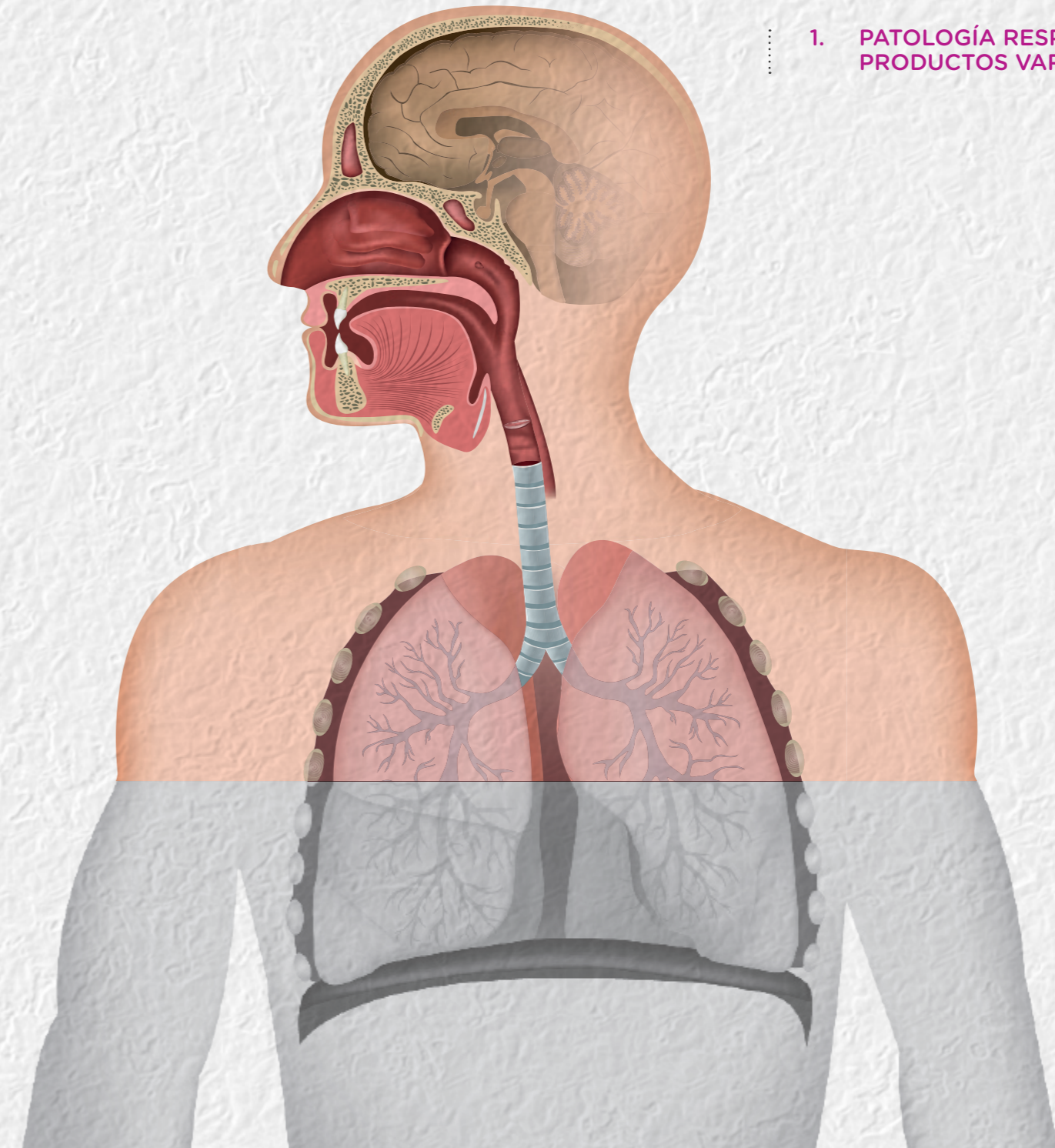

1. PATOLOGÍA RESPIRATORIA/  
PRODUCTOS VARIOS ..... P.157

# 1 PATOLOGÍA RESPIRATORIA/PRODUCTOS VARIOS

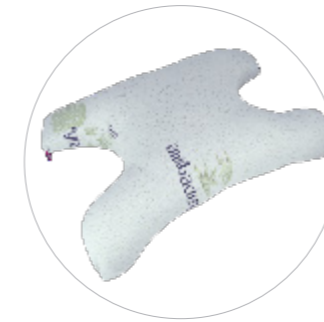

QBIO  
Almohada  
CPAP nasal

MEDIDAS CN  
53x33,5x11 cm 189360



QBIO  
307250  
Cinturón  
posicionador  
lateral para  
apneas

CN  
098703



QBIO  
Babero para  
traqueotomías

ENVASE CN  
10 uds 098704



NEBULFARMA  
Incentivador  
respiratorio

CN  
158676



PRIM  
Nevera  
porta-insulina

MEDIDAS CN  
10x20 cm 047893



NEVE-PAX  
Nevera  
porta-insulina

MEDIDAS CN  
10x20 cm 332452



APEX  
CPAP XT SERIES  
Calentador /  
humidificador

CN  
099024



APEX  
CPAP XT FIT

CN  
099023

**15** PRODUCTOS DE ALQUILER  
Y SERVICIOS DE ATENCIÓN  
DOMICILIARIA



INTRODUCCIÓN.....P.161







SERVICIOS ESPECIALES:  
ALQUILER Y AYUDAS

## 1 SERVICIOS DE ATENCIÓN DOMICILIARIA

Teniendo en cuenta que:



80%

De las personas mayores o con diversidades funcionales, quieren seguir viviendo en su domicilio y entorno.

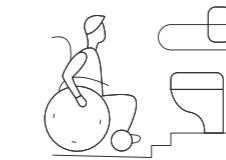

77%

Viven en hogares no adaptados a sus necesidades.

Desde fedefarma, hemos conseguido los mejores *partners* para poder dar soporte en situaciones de necesidad domiciliaria.

Si necesitas alquilar camas, grúas, sillas o detectas clientes con necesidades especiales, escríbenos a [ortopedia@fedefarma.com](mailto:ortopedia@fedefarma.com) y **¡coméntanos el caso!**

## 2 MONTAJE DE SALVAESCALERAS

Un gran obstáculo en muchos hogares son las escaleras y los accesos. Podemos ponerte en contacto con empresas que ofrecen este servicio. Sólo ¡pregúntanos! [ortopedia@fedefarma.com](mailto:ortopedia@fedefarma.com)

## 3 ALQUILER DE APARATOS DE MAGNETOTERAPIA Y TENS

Cada vez es más frecuente seguir o acompañar la rehabilitación médica con aparatos en casa.

En fedefarma, disponemos de aparatos sencillos pero muy efectivos, para que puedas dar el servicio de alquiler desde tu farmacia.

Como siempre, sólo tienes que pedirlo: [ortopedia@fedefarma.com](mailto:ortopedia@fedefarma.com)



**PAO  
ADAP**

**PAO  
BAS**

## PAOS

Aquí encontrarás un resumen de los códigos PAO BAS y ADAP más habituales en farmacia-ortopedia, así como el producto que entraría, según la propuesta de cada laboratorio hecha al SNS.

**Nota:** en breve, los productos ortopédicos llevarán cupón precinto.  
En este catálogo encontrarás los PAOS que, hasta ahora, estaban financiados.  
En caso de incorporarse productos nuevos, te lo comunicaremos una vez se confirmen.  
Por el momento, te dejamos una guía.

### ÓRTESIS CERVICAL

Aportación del usuario: 30€

(ver página 11)

060312

#### OTC 000

Órtesis cervical  
semirígida



#### OTC 000A

43,20€

DJO  
COLLARÍN  
CALIFORNIA

#### OTC 010

Órtesis cervical  
rígida



#### OTC 010A

179,28€

PRIM  
E120



THUASNE  
ORTEL C4  
VARIO

### ÓRTESIS DE HOMBRO, CODO Y MUÑECA

Aportación del usuario: 30€

(ver página 15-16)

060627

#### OSH 000

Órtesis pasiva  
de hombro, codo  
y muñeca, sin  
articulación



#### OSH 000B

132,48€

TEYDER  
430CH



#### OSH 000A

270,60€

PRIM  
903



DJO  
IMMOSCAP



TEYDER  
437CH

### ÓRTESIS DE CODO

Aportación del usuario: 30€

(ver página 16)

060615

#### OSC 000

Órtesis pasiva  
de codo



#### OSC 000A

165,57€

TEYDER  
432CD

#### OSC 010

Órtesis activa  
de codo



#### OSC 010A

331,89€

PRIM  
C202

### ÓRTESIS PASIVA DE ANTEBRAZO

Aportación del usuario: 30€

(ver página 16)

060620

#### OSA 000

Órtesis pasiva  
de antebrazo,  
prefabricada



#### OSA 000A

111,24€

EMO  
FAB20

**ÓRTEISIS DE DEDOS**

*Aportación del usuario: 12€*  
(ver página 21)  
060603

**OSD 000**  
Órtesis pasiva  
para dedo pulgar



**OSD 000A**  
**68,50€**  
ORLIMAN  
RHIZO MP  
ACE510



PRIM  
ESSENCIAL  
C400



ORLIMAN  
FP-174



ACTIMOVE  
RHIZO FORTE



ACTIMOVE  
THUMB  
ESTABILIZER



PRIM  
112900

(ver página 22)

**OSD 010**  
Órtesis pasiva  
para dedo



**OSD 010A**  
**25,29€**  
PRIM  
940



PRIM  
STACK  
947



PRIM  
STACK  
948



ORLIMAN  
ACV504



ORLIMAN  
ACV502

(ver página 21)

**OSD 020**  
Órtesis activa  
para dedo  
pulgar



**OSD 020A**  
**73,16€**  
PRIM  
CMC DE  
PUSH 3101

(ver página 23)

**OSD 030**  
Órtesis activa  
flexora/extensora  
para dedo



**OSD 030A**  
**42,64€**  
PRIM  
112510



**OSD 030B**  
**42,64€**  
THUASNE  
601

**ÓRTEISIS DE MANO/MUÑECA**

*Aportación del usuario: 30€*  
(ver página 19)  
060612

**OSN 000**  
Órtesis pasiva  
de muñeca



**OSN 000A**  
**61,60€**



ACTIMOVE  
MANUS  
FORTE



PRIM  
ESSENCIAL  
C500



ORLIMAN  
IMMOTEC



PRIM  
AIRMED  
AM205G

**ÓRTEISIS DE MANO/MUÑECA/DEDOS**

*Aportación del usuario: 30€*  
(ver página 20)  
060613

**OSU 000**  
Órtesis pasiva  
de muñeca,  
mano y dedos



**OSU 000A**  
**125,92€**



ACTIMOVE  
MANUS  
FORTE PLUS



PRIM  
ESSENCIAL  
C800



ORLIMAN  
ACE506  
MANU EASY



ORLIMAN  
ACE513  
MANU EASY

**ÓRTEISIS DE MANO**

*Aportación del usuario: 12€*  
(ver página 23)  
060606

**OSM 000C**  
**121,97€**  
Órtesis pasiva  
para mantener  
las articulaciones  
MTF



THUASNE  
AIR-SOFT  
STABLE 326

**OSM 010A**  
**122,55€**  
Órtesis activa  
extensora de  
articulaciones  
MTF



THUASNE  
PUCCI AIR  
ROLL 413

## ÓRTESIS DE COLUMNA VERTEBRAL

Aportación del usuario: 30€

(ver páginas 30-31)

060306

**OTL 000**  
Órtesis  
lumbo-sacra  
semirígida

**OTL 000A**  
68,28€

Con flejes  
posteriores

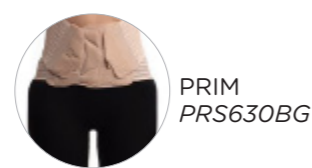

PRIM  
PRS630BG



PRIM  
PRS625N



ORLIMAN  
LOMBOFIT



PRIM  
CARE+  
PRS620BG

PAO  
BAS



ORLIMAN  
ACE609  
EVOLUTIVE

**OTL 000B**  
88,20€

Tejido no  
elástico



DJO  
IMMOSTRAP



PRIM  
ELCROSS  
GOLD 232

PAO  
BAS

**OTL 000C**  
99€

Tejido no  
elástico para  
abdomen en  
péndulo

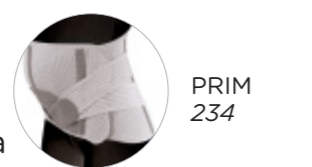

PRIM  
234

PAO  
ADAP

**OTL 000D**  
99€

Órtesis para  
eventración/  
ostomía



PRIM  
FAJA  
STOMACARE  
P302

PAO  
ADAP

**OTL 010**  
Órtesis  
lumbo-sacra  
rígida

**OTL 010D**  
218,10€

Con carcasa  
rígida  
posterior y  
tejido elástico

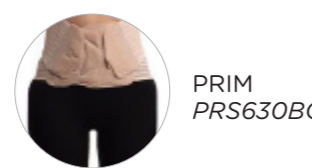

PRIM  
PRS630BG



MÓDULO  
PRS650BG

PAO  
ADAP

## ÓRTESIS TORACOLUMBOSACRA (DORSOLUMBAR)

Aportación del usuario: 30€

(ver páginas 27-31)

060306

**OTD 000**  
Órtesis  
toraco-lumbar  
semirígida

PAO  
ADAP

**OTD 000A**  
104,50€

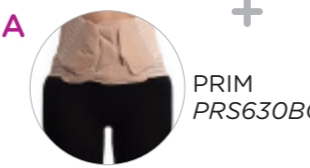

PRIM  
PRS630BG



MÓDULO  
PRS650BG



PRIM  
PRS636BG  
OS



TEYDER  
707FV

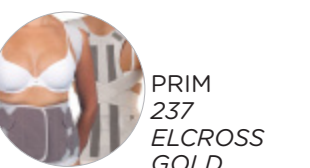

PRIM  
237  
ELCROSS  
GOLD

**OTD 000B**  
104,50€



PRIM  
ELCROSS  
GOLD 234

(ver página 32)

**OTD 020**  
Órtesis  
toraco-lumbar  
rígida

PAO  
ADAP

**OTD 020E**  
341,00€



PRIM  
SP500  
SPIN AIR

(ver página 32)

**OTD 080**  
Órtesis de  
hiperextensión

PAO  
ADAP

**OTD 080A**  
216,37€

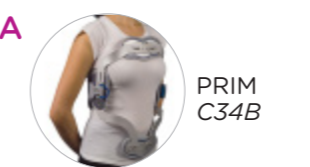

PRIM  
C34B

**OTD 080C**  
234,37€



PRIM  
AVANT  
C35+AV

**ÓRTESIS DE RODILLA**

Aportación del usuario: 30€

061209

(ver página 38)

**OIR 000**

Órtesis pasiva para la inmovilización de rodilla

**OIR 000A**  
98,45€

Sin articulación



ORLIMAN GENU'R



DJO IMMO AT43V



**OIR 000B**  
137,39€

Con articulación



MC DAVID 429



TEYDER 236RD



(ver página 38)

**OIR 010**

Órtesis de rodilla con sistema de estabilización

**OIR 010A**  
75,90€



MC DAVID 421

**OIR 010B**  
87,59€



DJO PLAYMAKER EXPERT WRAP



DJO STABILAX



ORLIMAN ROTULIG STAB ACE809



TEYDER 235RD

(ver página 39)

**OIR 020**

Órtesis estabilizadora con articulación graduable en flexo-extensión.

**OIR 020A**  
210,10€

Monocéntrica



DJO X-ACT ROM LITE

**OIR 020B**  
272,59€

Policéntrica



DJO PLAYMAKER II

**ÓRTESIS DE TOBILLO**

Aportación del usuario: 30€

061206

(ver página 41)

**OIT 030A**  
110,00€



(ver página 41)

**OIT 040A**  
259,26€



(ver página 41)

**OIT 050A**  
99,72€



(ver página 41)

**OIT 050B**  
53,90€



(ver página 41)

**OIT 050C**  
89,73€



(ver página 52)

**OIT 060A**  
127,26€



(ver página 52)

**OIT 060D**  
124,98€



**WALKERS Fijos**



ORLIMAN BOTIMED ACV904



ORLIMAN ACV905



DJO WALKERS INFANTILES

**WALKERS Articulados y de aire**



ORLIMAN BOTIMED ACV903



DJO MAXTRAX ROM



THUASNE XLR8



DJO AIR SELECT



DJO AIRCAST AIRSPORT



DJO FUSIOLIGHT



DJO SPEED PRO



ORLIMAN MEMOFORCE ACV901



PRIM T116 AIRTEX

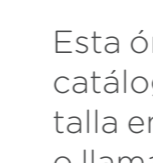

EMO AFO100 ANTIEQUINO



PRIM AIRMED ATX11



PRIM AIRMED ATX01

Esta órtesis no aparece en el catálogo. Encontrarás su código y talla en tu área privada de fedefarma o llamando al SAS.

**MULETAS**

Aportación del usuario: 12€  
(ver página 102)  
120309

**EMS 000A**  
23,82€

Entra cualquier muleta con empuñadura anatómica

**EMT 000A**  
44,97€



GARCÍA 2132



GARCÍA 3521

**ANDADORES**

Aportación del usuario: 30€  
(ver páginas 106-111)  
120600

**EAN 000**  
Sin ruedas



**EAN 000A**  
75,53€



GARCÍA 2107

**EAN 000B**  
82,40€



GARCÍA 2109



GARCÍA 2108

**EAN 000C**  
104,46€



GARCÍA 2111

**EAN 010**  
Con ruedas



**EAN 010A**  
93,91€



FORTA CAR



FORTA AIR

**EAN 010B**  
101,48€



KMINA COMFORT 2 ruedas



FORTA KAMALEÓN



GARCÍA 2214N

**EAN 010C**  
130,52€

Resto de andadores de exterior con la marca de PAO

**SILLAS MANUALES**

Aportación del usuario: 0€  
(ver páginas 114-115)  
122200

Básica



VERMEIREN JAZZ



258,15€

Acero

Rueda grande SRM040A

Rueda pequeña SRM010A

Usuarios/acompañantes altos o usuarios escurridizos.



VERMEIREN D100

Aluminio. Para usuarios/acompañantes con dificultad para coger peso.



GARCÍA 2240 VERMEIREN ECLIPS



413,23€

Aluminio

Rueda grande SRM040D

Reclinable. Para usuarios con esa necesidad



VERMEIREN D100 30



478,85€

Reclinable

Rueda grande SRM040B

Rueda pequeña SRM010B

Para usuarios de más de 130kg



VERMEIREN V100 VERMEIREN V300



549,87€

+130Kg

Rueda grande SRM040C

Rueda pequeña SRM010C

Usuarios activos con patología medular



TRIGO



2.000,85€

Patología medular

Rueda grande SRM040F

Alteraciones neurológicas graves



VERMEIREN INOVYS



2.574,79€

Alteraciones graves

Rueda pequeña SRM050C

**SILLAS ELÉCTRICAS**

Aportación del usuario: 0€  
(ver páginas 118-122)  
122306

**SRE000**

Todos los productos del catálogo que estén identificados con la marca PAO.



**SRE000C**

Silla eléctrica para usuarios de más de 130 Kg.



**COJINES ANTIESCARAS**

*Aportación del usuario: 30€*

(ver página 152)

043300

**ECJ 000**

*115,97€*



Todos los cojines mostrados en este catálogo entran por este código.



*Si buscas un código que no encuentras, escríbenos a:*  
**[ortopedia@fedefarma.com](mailto:ortopedia@fedefarma.com)**

Los de aire propuestos aquí, no cumplen las condiciones para el PAO ADAP, y se salen de precio para el BAS.

Anotaciones



Lined area for notes with a vertical red dotted line on the left side.



3M **FUTURO**

**acofar**

**Actimove**

**actius**<sup>®</sup>  
by **ORLIMAN**

**APEX**

**BASE 25**

**CALVO IZQUIERDO SL**  
LABORATORIO FARMACÉUTICO

**Carbóvital**

**cinfa**

**CLEMENT SALUS**

**CQF**  
Comercial Quirúrgica Farmacéutica

**DJO**

**EMO**  
especialista en ortopedia

**FLEXOR**  
foolbeds & pads

**FORTA**<sup>®</sup>  
FABRICACIONES ORTOPÉDICAS ALBACETE, S.L.

**García 1880**  
NEVEDAS

**karma**  
A Better Wheelchair, A Better Fit

**Iásticbass**

**MEDAVIA**

**ORTO VALORA**

**PRIM**

**SIGVARIS**

**smou**

**STEYDER**  
ESTRUCTURAS ORTOPÉDICAS

**THUASNE**

**Qbio**  
quality life

**VERMEIREN**

**Vm. Vettelgroup**  
Medical equipment

**VOE**

## Catálogo Ortopedia fedefarma 2021/2022

**Contenidos:** Clara Pérez-Bonfils Llauradó, farmacéutica y ortopeda con más de 15 años de experiencia, en los que ha ejercido como farmacéutica comunitaria, dirigido su propia ortopedia e incluso patentado un producto de la categoría.

**Nº Colegiada:** 16613.

**Corrección y revisión:** Yeray Deus. **Maquetación:** Eduard Palos.

---



[fedefarma.com](http://fedefarma.com)